

Go to [www.vtechphones.com](http://www.vtechphones.com) to register your product for enhanced warranty support and latest VTech product news.

SN6187

VTech CareLine™



# vtech®

## User's manual

# Congratulations

on purchasing your new VTech product. Before using this telephone, please read **Important safety instructions**.

This manual has all the feature operations and troubleshooting necessary to install and operate your new VTech telephone. Please review this manual thoroughly to ensure proper installation and operation of this innovative and feature rich VTech product.

For support, shopping, and everything new at VTech, visit our website at [www.vtechphones.com](http://www.vtechphones.com). In Canada, please visit [www.vtechcanada.com](http://www.vtechcanada.com).



Telephones identified with this logo have reduced noise and interference when used with most T-coil equipped hearing aids and cochlear implants. The TIA-1083 Compliant Logo is a trademark of the Telecommunications Industry Association. Used under license.



The ENERGY STAR® program ([www.energystar.gov](http://www.energystar.gov)) recognizes and encourages the use of products that save energy and help protect our environment. We are proud to mark this product with the ENERGY STAR® label indicating it meets the latest energy efficiency guidelines.

# Important safety instructions

When using your telephone equipment, basic safety precautions should always be followed to reduce the risk of fire, electric shock and injury, including the following:

1. Read and understand all instructions.
2. Follow all warnings and instructions marked on the product.
3. Unplug this product from the wall outlet before cleaning. Do not use liquid or aerosol cleaners. Use a damp cloth for cleaning.
4. Do not use this product near water such as near a bath tub, wash bowl, kitchen sink, laundry tub or a swimming pool, or in a wet basement or shower.
5. Do not place this product on an unstable table, shelf, stand or other unstable surfaces.
6. Slots and openings in the back or bottom of the telephone base and handset are provided for ventilation. To protect them from overheating, these openings must not be blocked by placing the product on a soft surface such as a bed, sofa or rug. This product should never be placed near or over a radiator or heat register. This product should not be placed in any area where proper ventilation is not provided.
7. This product should be operated only from the type of power source indicated on the marking label. If you are not sure of the type of power supply in your home or office, consult your dealer or local power company.
8. Do not allow anything to rest on the power cord. Do not install this product where the cord may be walked on.
9. Never push objects of any kind into this product through the slots in the

telephone base or handset because they may touch dangerous voltage points or create a short circuit. Never spill liquid of any kind on the product.

10. To reduce the risk of electric shock, do not disassemble this product, but take it to an authorized service facility. Opening or removing parts of the telephone base or handset other than specified access doors may expose you to dangerous voltages or other risks. Incorrect reassembling can cause electric shock when the product is subsequently used.
11. Do not overload wall outlets and extension cords.
12. Unplug this product from the wall outlet and refer servicing to an authorized service facility under the following conditions:
  - When the power supply cord or plug is damaged or frayed.
  - If liquid has been spilled onto the product.
  - If the product has been exposed to rain or water.
  - If the product does not operate normally by following the operating instructions. Adjust only those controls that are covered by the operation instructions. Improper adjustment of other controls may result in damage and often requires extensive work by an authorized technician to restore the product to normal operation.
  - If the product has been dropped and the telephone base and/or handset has been damaged.
  - If the product exhibits a distinct change in performance.
13. Avoid using a telephone (other than cordless) during an electrical storm. There is a remote risk of electric shock from lightning.
14. Do not use the telephone to report

a gas leak in the vicinity of the leak. Under certain circumstances, a spark may be created when the adapter is plugged into the power outlet, or when the handset is replaced in its cradle. This is a common event associated with the closing of any electrical circuit. The user should not plug the phone into a power outlet, and should not put a charged handset into the cradle, if the phone is located in an environment containing concentrations of flammable or flame-supporting gases, unless there is adequate ventilation. A spark in such an environment could create a fire or explosion. Such environments might include: medical use of oxygen without adequate ventilation; industrial gases (cleaning solvents; gasoline vapors; etc.); a leak of natural gas; etc.

15. Only put the handset of your telephone next to your ear when it is in normal talk mode.
16. The power adapter is intended to be correctly oriented in a vertical or floor mount position. The prongs are not designed to hold the plug in place if it is plugged into a ceiling, under-the-table or cabinet outlet.

## **SAVE THESE INSTRUCTIONS**

### **Battery**

- **CAUTION:** Use Only Supplied Battery.
- Do not dispose of the battery in a fire. Check with local waste management codes for special disposal instructions.
- Do not open or mutilate the battery. Released electrolyte is corrosive and may cause burns or injury to the eyes or skin. The electrolyte may be toxic if swallowed.
- Exercise care in handling batteries in order not to create a short circuit with conductive materials.

- Charge the battery provided with this product only in accordance with the instructions and limitations specified in this manual.

## **Precautions for users of implanted cardiac pacemakers**

Cardiac pacemakers (applies only to digital cordless telephones):

Wireless Technology Research, LLC (WTR), an independent research entity, led a multidisciplinary evaluation of the interference between portable wireless telephones and implanted cardiac pacemakers. Supported by the U.S. Food and Drug Administration, WTR recommends to physicians that:

### **Pacemaker patients**

- Should keep wireless telephones at least six inches from the pacemaker.
- Should NOT place wireless telephones directly over the pacemaker, such as in a breast pocket, when it is turned ON.
- Should use the wireless telephone at the ear opposite the pacemaker.

WTR's evaluation did not identify any risk to bystanders with pacemakers from other persons using wireless telephones.

**Note:** The CareLine™ transmitter is a wireless telephone, and it should not be used in the pendant form (hanging from a necklace over the heart) by persons wearing pacemakers. Pacemaker patients should use the CareLine™ product in belt-clip form only.

### **About cordless telephones**

- **Privacy:** The same features that make a cordless telephone convenient create some limitations. Telephone calls are transmitted between the telephone base and the cordless handset by radio waves, so there is a possibility that the cordless telephone conversations

could be intercepted by radio receiving equipment within range of the cordless handset. For this reason, you should not think of cordless telephone conversations as being as private as those on corded telephones.

- **Electrical power:** The telephone base of this cordless telephone must be connected to a working electrical outlet. The electrical outlet should not be controlled by a wall switch. Calls cannot be made from the cordless handset if the telephone base is unplugged, switched off or if the electrical power is interrupted.
- **Potential TV interference:** Some cordless telephones operate at frequencies that may cause interference to televisions and VCRs. To minimize or prevent such interference, do not place the telephone base of the cordless telephone near or on top of a TV or VCR. If interference is experienced, moving the cordless telephone farther away from the TV or VCR often reduces or eliminates the interference.
- **Rechargeable batteries:** Exercise care in handling batteries in order not to create a short circuit with conducting material such as rings, bracelets and keys. The battery or conductor may overheat and cause harm. Observe proper polarity between the battery and the battery charger.
- **Nickel-metal hydride rechargeable batteries:** Dispose of these batteries in a safe manner. Do not burn or puncture the battery. Like other batteries of this type, if burned or punctured, they could release caustic material which could cause injury.

# Table of contents

<b>What's in the box</b> .....	<b>1</b>
<b>Overview</b> .....	<b>2</b>
Telephone base overview .....	2
Handset overview.....	2
Pendant overview.....	4
Display icons overview.....	4
Telephone base lights overview .....	5
Handset lights overview .....	5
Pendant lights overview .....	5
<b>Connect</b> .....	<b>6</b>
Connect the telephone base .....	6
Connect the pendant charger .....	6
Mount the telephone base.....	6
Install and charge the battery.....	7
Battery backup .....	8
<b>Before use</b> .....	<b>9</b>
Set date and time .....	9
Check for dial tone .....	9
Positioning your pendant.....	9
Operating range .....	10
<b>Configure your telephone</b> .....	<b>10</b>
Use the handset menu .....	10
Set language .....	10
Use caller ID to automatically set date and time .....	10
Set date and time .....	11
Caller ID announce .....	11
Talking digit.....	11
Happy message .....	12
Home area code.....	12
Dial mode .....	12
Temporary tone dialing.....	12
Rename handset.....	13
<b>Speed dial</b> .....	<b>13</b>
Assign or edit a speed dial entry.....	13
Dial a speed dial number .....	14

<b>Telephone operations</b> .....	<b>14</b>
Make a call .....	15
Redial a call.....	15
Answer a call.....	15
End a call:.....	15
Speakerphone.....	15
Volume .....	15
Equalizer .....	15
Audio Assist® .....	16
Mute .....	16
Join a call in progress .....	16
Call waiting .....	16
Chain dialing.....	17
Transfer a call.....	17
Find handset and pendant .....	18
<b>Redial list</b> .....	<b>18</b>
Review a redial list entry .....	18
Dial a redial list entry .....	18
Delete a redial list entry.....	18
<b>Multiple handset use</b> .....	<b>19</b>
Intercom .....	19
Answer an incoming call during an intercom call.....	19
Call transfer using intercom .....	20
<b>Phonebook</b> .....	<b>21</b>
Add a phonebook entry .....	21
Review a phonebook entry .....	21
Alphabetical search.....	22
Delete a phonebook entry.....	22
Edit a phonebook entry .....	22
Dial a phonebook entry .....	22
<b>Caller ID</b> .....	<b>23</b>
Review a caller ID log entry .....	23
Memory match.....	23
Missed call indicator.....	23
View dialing options.....	24
Dial a caller ID log entry .....	24
Save a caller ID log entry to the phonebook.....	24
Delete the caller ID log entries .....	24



<b>Sound settings</b> .....	<b>25</b>	<b>Remote access</b> .....	<b>36</b>
Quiet mode.....	25	Access your reminders remotely.....	36
Key tone .....	25	Access your answering system	
Handset ringer tone.....	25	remotely .....	36
Pendant ringer tone.....	26	Set your remote access code .....	37
Telephone base ringer volume.....	26	<b>Voice command</b> .....	<b>38</b>
Handset ringer volume .....	26	Turn the voice command on or off .....	38
Pendant ringer volume .....	26	Use the voice command.....	38
Temporary ringer silencing .....	26	Common commands .....	38
<b>Reminder</b> .....	<b>27</b>	Commands to review reminders .....	38
Turn the reminder on or off.....	27	Commands to review messages.....	39
Add a reminder.....	27	Commands to review caller ID log .....	39
Review reminders .....	28	<b>Expand your telephone system</b> .....	<b>39</b>
Add and review reminders remotely .....	28	Add and register a handset.....	39
<b>About the built-in answering system</b>		Add and register a pendant.....	40
<b>and voicemail service</b> .....	<b>28</b>	Deregister all devices.....	40
<b>Set your built-in answering system</b> .....	<b>29</b>	<b>Other information</b> .....	<b>41</b>
Turn the answering system on or off.....	29	Website .....	41
Default announcement.....	30	<b>Screen messages</b> .....	<b>41</b>
Record your own announcement.....	30	<b>ECO mode</b> .....	<b>44</b>
Play the announcement .....	30	<b>General product care</b> .....	<b>44</b>
Delete the announcement.....	30	<b>Frequently asked questions</b> .....	<b>45</b>
Set number of rings.....	31	<b>The RBRC® seal</b> .....	<b>48</b>
Set recording time .....	31	<b>FCC, ACTA and IC regulations</b> .....	<b>49</b>
Turn the call screening on or off.....	31	<b>California Energy Commission</b>	
Turn the message alert tone on or off .....	31	<b>battery charging testing</b>	
<b>Use your built-in answering system</b> .....	<b>32</b>	<b>instructions</b> .....	<b>51</b>
New message indication .....	32	<b>For C-UL compliance only</b> .....	<b>52</b>
Message playback .....	32	<b>Limited warranty</b> .....	<b>55</b>
Delete all messages.....	33	<b>Technical specifications</b> .....	<b>57</b>
Call screening.....	34		
Call intercept .....	34		
Record, play or delete memos .....	34		
<b>Use the built-in answering system</b>			
<b>and voicemail service</b> .....	<b>35</b>		
<b>Retrieve voicemail from telephone</b>			
<b>service</b> .....	<b>35</b>		
Retrieve voicemail.....	35		
Set your voicemail number.....	35		
Turn off the new voicemail indicators.....	36		

# What's in the box

Your telephone package contains the following items. Save your sales receipt and original packaging in the event warranty service is necessary.

## NOTE

- To purchase a replacement battery or power adapter, visit our website at [www.vtechphones.com](http://www.vtechphones.com) or call 1 (800) 595-9511. In Canada, go to [www.vtechcanada.com](http://www.vtechcanada.com) or call 1 (800) 267-7377.

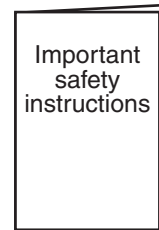
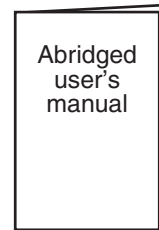
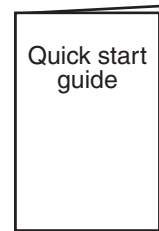
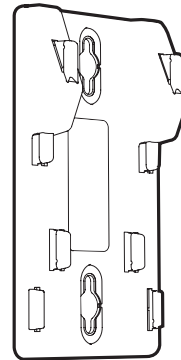
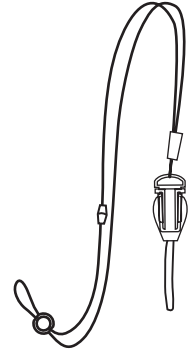
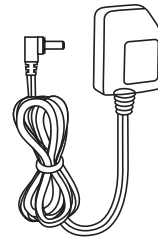
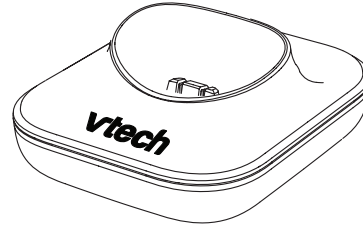
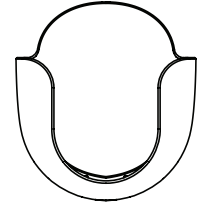
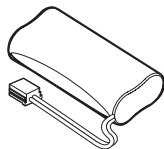
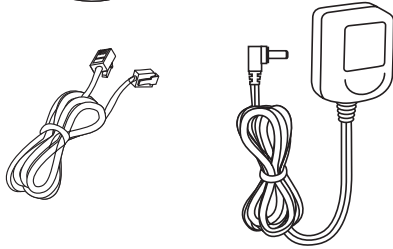
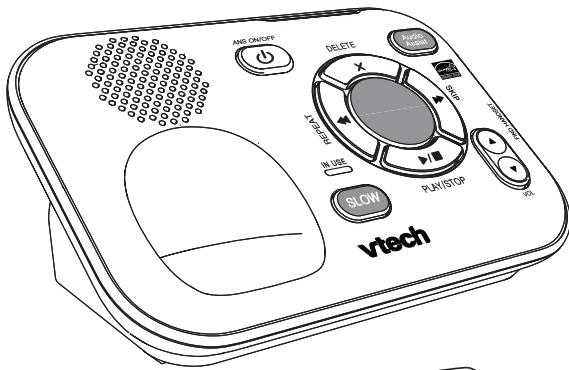

# Overview

## Telephone base overview

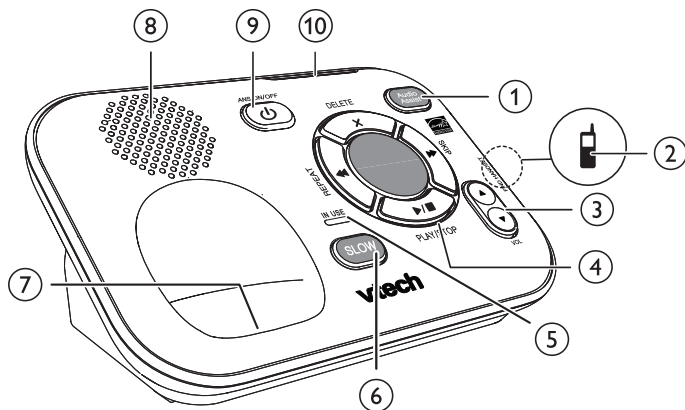

### 1 – Audio Assist

- Enhance the clarity and loudness of the caller's voice during message playback.

### 2 – FIND HANDSET

- Page all handsets and pendants when idle.

### 3 – ▲/VOL and ▼/VOL

- Adjust the listening volume during message playback.
- Adjust the base ringer volume while idle.

### 4 – Message window

- Show the number of messages, and the other information of the answering system or telephone base.

### X/DELETE

- Delete the playing message.
- Press twice to delete all old messages.

### ◀◀/REPEAT

- Repeat a message.
- Press twice to play the previous message.

### ▶▶/SKIP

- Skip to the next message.

### ▶/■/PLAY/STOP

- Play messages.
- Stop playing messages.

### 5 – IN USE light

- On when the phone is in use or the answering system is answering an incoming call.
- On when a device is being registered.
- Flashes when devices are being deregistered.
- Flashes when another telephone on the same line is in use.

### 6 – SLOW

- Press to slow down the message playback.

### 7 – Charging pole

### 8 – Speakerphone

### 9 – /ANS ON/OFF

- Turn on or off the answering system.

### 10 – Visual ringer indicator

- Flashes when the telephone base is ringing.

## Handset overview

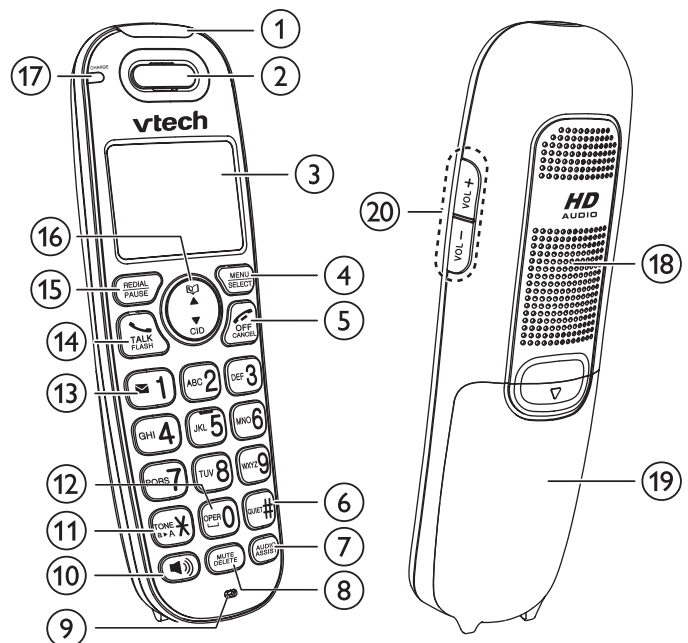



## 1 – Visual ringer indicator

- Flashes when the handset is ringing.

## 2 – Handset earpiece

## 3 – LCD display

### 4 –

- Show the menu.
- While in a menu, press to select an item, or save an entry or setting.

### 5 – /CANCEL

- Hang up a call.
- Return to the previous menu or idle mode without making changes.
- Delete digits while predialing.
- Silence the handset ringer temporarily while the phone is ringing.
- Erase the missed call indicator while the handset is not in use.

### 6 –

- Turn on or off the quiet mode.
- Show other dialing options when reviewing a caller ID log entry.
- Silence the handset ringer temporarily while the phone is ringing.

### 7 –

- Enhance the clarity and loudness of the caller's voice during a call.

### 8 –

- Mute the microphone during a call.
- Silence the handset ringer temporarily while the phone is ringing.
- Delete the displayed entry while reviewing the phonebook, caller ID log or redial list.
- Delete digits or characters when entering numbers or names.

## 9 – Microphone

### 10 –

- Make or answer a call using the handset speakerphone.

- Switch between the handset speakerphone and the handset earpiece during a call.

### 11 –

- Switch to tone dialing temporarily during a call.
- Switch between upper case and lower case while entering characters.

### 12 –

- Enter space character during text editing.

### 13 –

- Press repeatedly to add or remove 1 in front of the caller ID log entry before dialing or saving it to the phonebook.
- Set or dial your voicemail number.

### 14 – /FLASH

- Make or answer a call.
- Answer an incoming call when you receive a call waiting alert.

### 15 –

- Review the redial list.
- Insert a dialing pause while dialing or entering numbers into the phonebook.

### 16 –

- Review the phonebook or caller ID log when the telephone is not in use.
- Scroll up or down while in a menu, or in the phonebook, caller ID log or redial list.
- Move the cursor to the left or right when entering numbers or names.

## 17 – CHARGE light

- On when the handset is charging.

## 18 – Speakerphone

## 19 – Battery compartment cover

## 20 – VOL+ and VOL-

- Adjust the listening volume during a call or message playback.
- Adjust the handset volume while idle

## Pendant overview

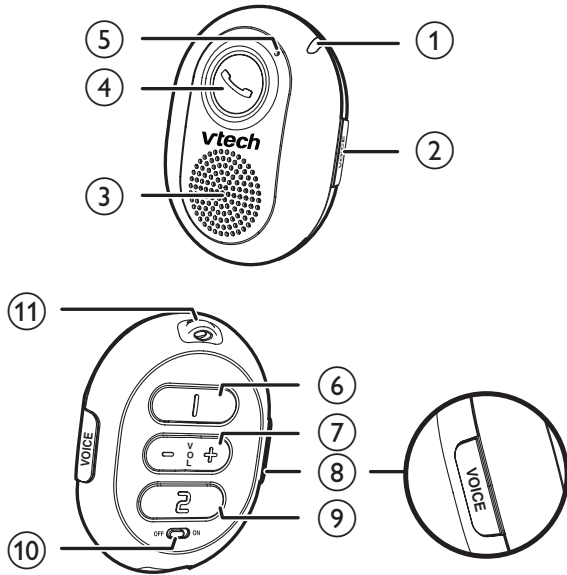

### 1 – Pendant status light

- Stays solid red when the pendant is charging.
- Flashes red when the pendant is in low battery.
- Stays solid green when the pendant is fully charged.
- Flashes red and green when the base is paging the pendant.
- Flashes quickly in red and green during pendant registration.
- Flashes orange three times when the pendant is not registered.

### 2 – VOICE

- Press to use the voice command feature.

### 3 – Speakerphone

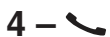

- Answer or end a call.

### 5 – Microphone

### 6 – 1

- Press to call speed dial 1.

### 7 – VOL- and VOL+

- Adjust the listening volume during a call or message playback.
- Adjust the pendant ringer volume while in idle mode.

### 8 – VOICE

- Press to use the voice command feature.

### 9 – 2

- Press to call speed dial 2.

### 10 – ON and OFF switch

- Switch to turn the pendant on or off.

### 11 – Slot for pendant lanyard

## Display icons overview

	The battery icon flashes when the battery is low and needs charging.
	The battery icon animates when the battery is charging.
	The battery icon becomes solid when the battery is fully charged.
	The handset speakerphone is in use.
	The handset ringer is turned off.
	There are new voicemail received from your telephone service provider.
<b>NEW</b>	There are new caller ID log entries.
<b>ANS ON</b>	The answering system is turned on.
	There are new messages in the answering system.
	The message number currently playing and total number of new/old messages recorded.
<b>MUTE</b>	The handset microphone is muted.
<b>AUDIO ASSIST</b>	The handset Audio Assist® feature is on.
<b>ECO</b>	The ECO mode activates automatically to reduce power consumption whenever the handset is synchronized with the telephone base.

## Telephone base lights overview

Visual ringer indicator	Flashes when the telephone base is ringing.
<b>IN USE</b>	<ul style="list-style-type: none"> <li>• On when the telephone line is in use.</li> <li>• On when the answering system is answering a call.</li> <li>• On when you are registering a handset or pendant.</li> <li>• Flashes when another telephone sharing the same line is in use.</li> <li>• Flashes when you are deregistering all devices.</li> </ul>
<b>🔌/ANS ON/OFF</b>	On when the answering system is turned on.

## Handset lights overview

Visual ringer indicator	Flashes when the handset is ringing.
<b>🔊</b>	On when the handset speakerphone is in use.
<b>CHARGE</b>	On when the handset is charging in the telephone base or charger.

## Pendant lights overview

Pendant status light	<ul style="list-style-type: none"> <li>• Stays solid red when the pendant is charging.</li> <li>• Flashes red when the pendant is in low battery.</li> <li>• Stays solid green when the pendant is fully charged.</li> <li>• Flashes red and green when the base is paging the pendant.</li> <li>• Flashes quickly in red and green during pendant registration.</li> <li>• Flashes orange three times when the pendant is not registered.</li> </ul>
Pendant light (ring around  )	<ul style="list-style-type: none"> <li>• On steady when the pendant is in use.</li> <li>• Flashes quickly when there is an incoming call.</li> <li>• Flashes twice every three seconds when another telephone system device is in use.</li> </ul>

## Connect

You can choose to connect the telephone base for desktop usage or wall mounting.

### NOTES

- Use only the adapters provided.
- Make sure the electrical outlets are not controlled by wall switches.
- The adapters are intended to be correctly oriented in a vertical or floor mount position. The prongs are not designed to hold the plug in place if it is plugged into a ceiling, under-the-table or cabinet outlet.

### TIP

- If you subscribe to digital subscriber line (DSL) high-speed Internet service through your telephone line, make sure you install a **DSL filter** (not included) between the telephone line cord and telephone wall jack. Contact your DSL service provider for more information.

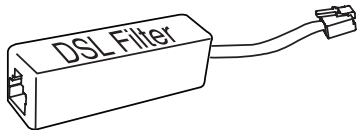

## Connect the telephone base

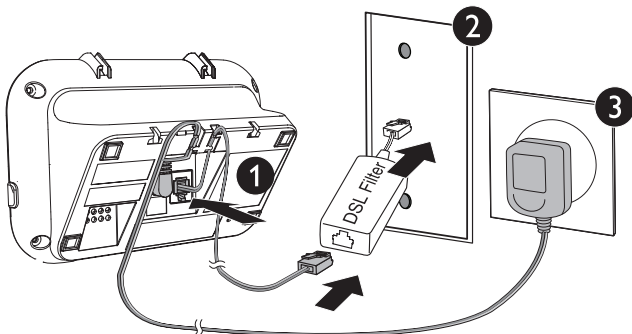

## Connect the pendant charger

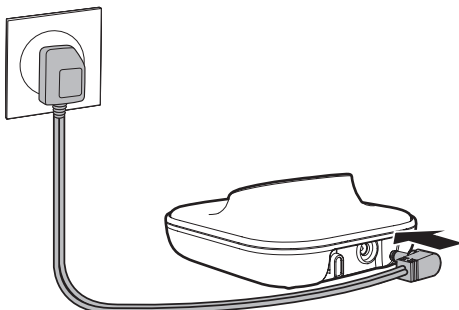

## Mount the telephone base

1. Connect the telephone line cord to the telephone base. Route it through the wall mount bracket, and then connect it to the wall jack.

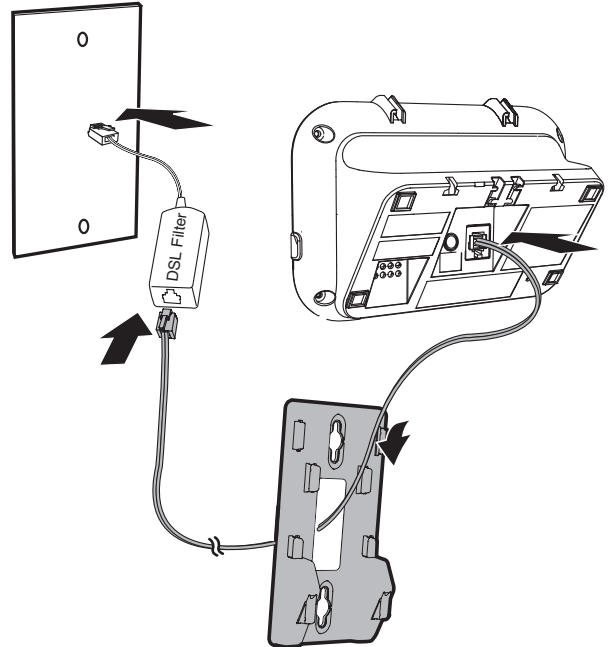

2. Align and place the wall mount bracket on the standard wall plate.

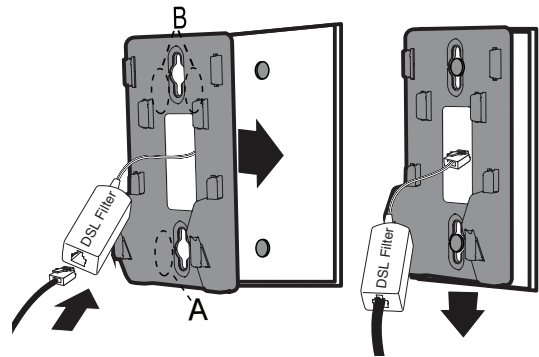

3. Align and place the telephone base on the wall mount bracket, and then connect the power adapter.

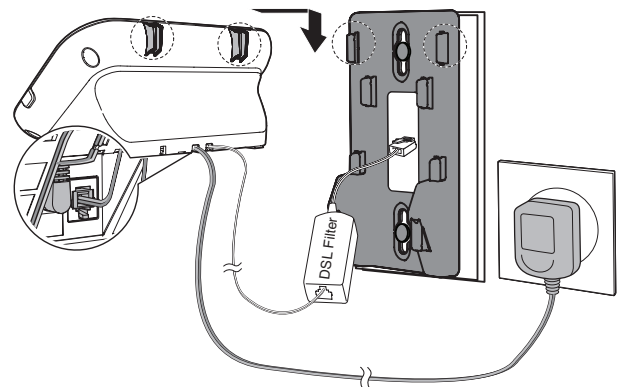

# Install and charge the battery

## Install the battery

Install the battery as shown below.

### NOTES

- Use only supplied battery.
- Charge the battery provided with this product only in accordance with the instructions and limitations specified in this manual.
- If the handset will not be used for a long time, disconnect and remove the battery to prevent possible leakage.

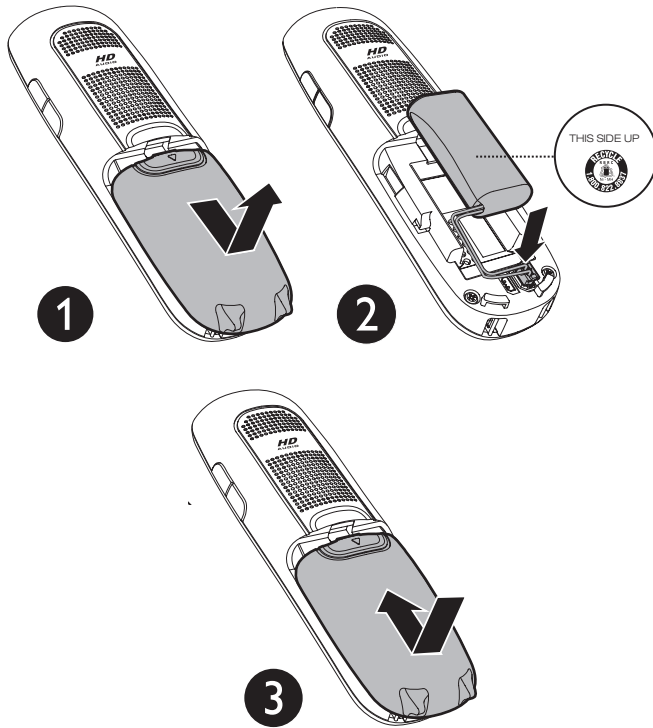

## Charge the handset battery

Place the handset in the telephone base to charge.

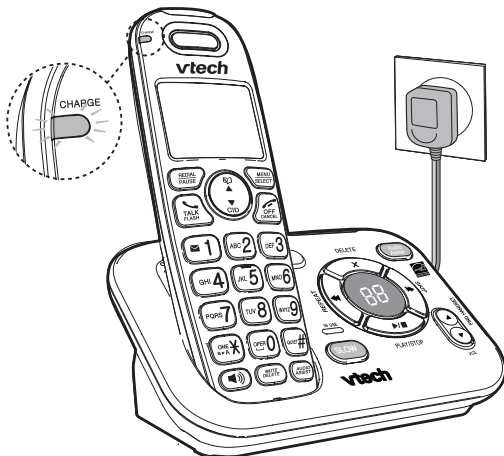

Once you have installed the battery, the handset LCD display indicates the battery status (see the following table).

### NOTES

- For best performance, keep the handset in the telephone base when not in use.
- The battery is fully charged after 11 hours of continuous charging.
- If you place the handset in the telephone base without plugging in the battery, the screen displays **No battery**.

Battery indicators	Battery status	Action
The screen is blank, or displays <b>Place in charger</b> and  flashes.	The battery has no or very little charge. The handset cannot be used.	Charge without interruption (at least 30 minutes).
The screen displays <b>Low battery</b> and  flashes.	The battery has enough charge to be used for a short time.	Charge without interruption (about 30 minutes).
The screen displays <b>HANDSET X</b> .	The battery is charged.	To keep the battery charged, place it in the telephone base when not in use.

When the battery is fully charged, you can expect the following performance:

Operation	Operating time
While in use (talking*)	Seven hours
While in speakerphone mode (talking*)	Five hours
While not in use (standby**)	Seven days

\* Operating times vary depending on your actual use and the age of the battery.

\*\* Handset is not charging nor in use.



## Charge the pendant battery

Switch on the pendant, and then place it in the pendant charger to charge.

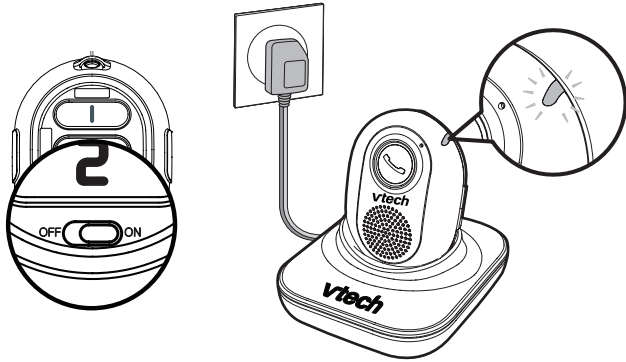

The pendant status light indicates the battery status (see the following table).

### NOTES

- For best performance, keep the pendant in the pendant charger when not in use.
- The battery is fully charged after 3 hours of continuous charging.

Battery indicators	Battery status	Action
The pendant status light flashes red. You hear “ <i>Low battery</i> ” when there is only 30 minutes talk time left. You hear an alert tone every one minute.	The battery has very little charge.	Charge without interruption.
The pendant status light is solid red.	The battery has enough charge to be used for a short time.	Charge without interruption.

When the battery is fully charged, you can expect the following performance:

Operation	Operating time
While in speakerphone mode (talking*)	Five hours

\* Operating times vary depending on your actual use and the age of the battery.

## Battery backup

When there is a power failure, all handsets display **Put HS on base to power base**. Put a charged handset in the telephone base to back up the telephone base power for some basic phone operations for a short period of time. During this period, you cannot use the answering system. If you have a pendant, you cannot use its voice command feature.

When a handset is put in the telephone base, it displays **Powering base... Don't pick up**. At this time, use other handsets for some basic phone operations. You may use the handset which is put in the telephone base for making or answering calls via the handset speakerphone, but do not pick up the handset while using it.

### NOTE

- When the cordless handset you put in the base does not have enough charge to back up the telephone base power, the handset displays **Not enough batt to power base**.

## Before use

After you install your telephone or power returns following a power outage, the handset will prompt you to set the date and time.

## Set date and time

### NOTE

- Make sure you set the date and time including the year correctly; otherwise the answering system does not announce the correct day of the week for your recorded messages time stamp.
1. Use the dialing keys (**0-9**) to enter the month (**MM**), date (**DD**) and year (**YY**). Then press **SELECT**.
  2. Use the dialing keys (**0-9**) to enter the hour (**HH**) and minute (**MM**). Then press ▼ or ▲ to choose **AM** or **PM**.
  3. Press **SELECT** to save.

## Check for dial tone

Press . If you hear a dial tone, the installation is successful.

### If you do not hear a dial tone:

- Make sure the installation procedures described above are properly done.
- It may be a wiring problem. If you have changed your telephone service to digital service from a cable company or a VoIP service provider, the telephone line may need to be rewired to allow all existing telephone jacks to work. Contact your cable/VoIP service provider for more information.

## Positioning your pendant

You can choose to wear the pendant with the provided pendant lanyard, or carry the pendant with the provided belt clip.

### Use the pendant lanyard:

Pinch the end of the lanyard and insert it into the slot on the top of the pendant.

Insert the one end of the lanyard into the other end of the lanyard, and fasten it.

You can adjust the length of the lanyard for comfortable wearing.

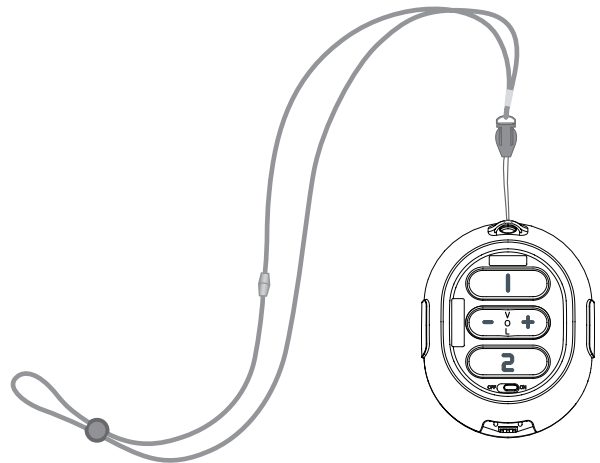

### Use the pendant belt clip:

Remove the necklace of the pendant lanyard or the whole pendant lanyard before you use the pendant belt clip.

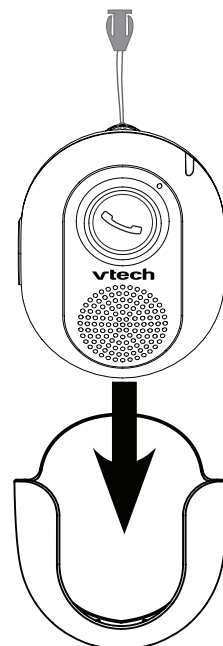

Push the pendant into the belt clip until it clicks in place.



## Operating range

This cordless telephone operates with the maximum power allowed by the Federal Communications Commission (FCC). Even so, this handset and telephone base can communicate over only a certain distance - which can vary with the locations of the telephone base and handset, the weather, and the layout of your home or office.

When the handset is out of range, the handset displays **Out of range OR Base no power**.

If there is a call while the handset is out of range, it may not ring, or if it does ring, the call may not connect well when you press . Move closer to the telephone base, then press  to answer the call.

If the handset moves out of range during a telephone conversation, there may be interference. To improve reception, move closer to the telephone base.

## Configure your telephone

### Use the handset menu

1. Press **MENU** when the phone is not in use.
2. Press ▼ or ▲ until the screen displays the desired feature menu.
3. Press **SELECT**.
  - To return to the previous menu, press **CANCEL**.
  - To return to idle mode, press and hold **CANCEL**.

### Set language

The LCD language is preset to English. You can select English, French or Spanish to be used in all screen displays.

1. Press **MENU** when the handset is not in use.
2. Press ▼ or ▲ to choose **Settings** and then press **SELECT** twice.
3. Press ▼ or ▲ to choose **English, Français** or **Español**.
4. Press **SELECT** twice to save your setting. You hear a confirmation tone.

### Use caller ID to automatically set date and time

If you subscribe to caller ID service, you can choose to set the date and time for each incoming call by the caller ID information automatically. The default setting is **On**.

1. Press **MENU** on the handset when not in use.
2. Press ▼ or ▲ to choose **Settings** and then press **SELECT**.
3. Press ▼ or ▲ to choose **CID time sync** and then press **SELECT**.
4. Press ▼ or ▲ to choose **On** or **Off**.
5. Press **SELECT** to save. You hear a confirmation tone.

## Set date and time

### NOTE

- Make sure you set the date and time including the year correctly; otherwise the answering system does not announce the correct day of the week for your recorded messages time stamp.

1. Press **MENU** on the handset when not in use.
2. Press **▼** or **▲** to choose **Set date/time** and then press **SELECT**.
3. Use the dialing keys (**0-9**) to enter the month (**MM**), date (**DD**) and year (**YY**). Then press **SELECT**.
4. Use the dialing keys (**0-9**) to enter the hour (**HH**) and minute (**MM**). Then press **▼** or **▲** to choose **AM** or **PM**.
5. Press **SELECT** to save your setting. You hear a confirmation tone.

## Caller ID announce

The caller ID announce feature lets you know who's calling without having to look at the display. When you have an incoming call, the handset and/or the telephone base speaks "Call from..." and the name of the caller based on the phonebook or caller ID information. If the caller's name is private or unknown, the phone number up to the last 11 digits will be announced. If the caller's phone number is also private or unknown, no information will be announced.

1. Press **MENU** when the handset is not in use.
2. Press **▼** or **▲** to choose **Annc Caller ID** and then press **SELECT**.
3. Press **▼** or **▲** to choose a desired option and then press **SELECT**.
  - **Set all On/Off** - Change the setting for all devices.
  - **Local handset** - Change the setting for that handset only.

- **Base** - Change the setting for the telephone base only.
- **Pendant** - Change the setting for the pendant only.

4. Press **▼** or **▲** to choose **On** or **OFF**, and then press **SELECT** to save your setting. You hear a confirmation tone.

### NOTES

- To use the caller ID announce feature, you must subscribe to caller ID service from your telephone service provider.
- When there are up to five handsets registered, the telephone system supports caller ID announce for all handsets. If six or more handsets are registered, the system supports caller ID announce for the first four registered handsets only.
- This feature does not announce information for call waiting calls.
- It takes at least 2 rings for the phone to receive caller ID information and announce it. If the phone is answered before the end of the second ring, the phone won't have time to announce the caller's information.
- Pronunciation of names may vary with this feature. Not all names may be pronounced correctly.
- Caller ID announce is available in English only.

## Talking digit

You can select the volume or turn off the audible spoken tone that is spoken when you press the dialing key during predialing.

1. Press **MENU** when the handset is not in use.
2. Press **▼** or **▲** to choose **Settings** and then press **SELECT**.
3. Press **▼** or **▲** to choose **Talking Digit** and then press **SELECT**.
4. Press **▼** or **▲** to sample each volume level.
5. Press **SELECT** to save. You hear a confirmation tone.

## Happy message

Happy messages are pendant greeting messages. It will occur when you pick up the pendant in the morning (between 4:30 am and 9:00 am), place the pendant on its charger at night (between 8:00 pm and 11:00 pm), or after using the voice command feature.

The default setting is **On**.

1. Press **MENU** when the handset is not in use.
2. Press ▼ or ▲ to choose **Pendant**, and then press **SELECT**.
3. Press ▼ or ▲ to choose **Happy message**, then press **SELECT**.
4. Press ▼ or ▲ to choose **On** or **Off**, then press **SELECT** to save. You hear a confirmation tone.

## Home area code

If you dial local calls using only seven digits (area code not required), you can program your home area code so that when you receive a call within your local area, the telephone number is automatically stored in the caller ID log without the area code.

1. Press **MENU** when the handset is not in use.
2. Press ▼ or ▲ to choose **Settings** and then press **SELECT**.
3. Press ▼ or ▲ to choose **Home area code**, and then press **SELECT**. The screen displays **Only for 7digit dial from CID**.
4. Use the dialing keys (0-9) to enter the desired home area code.
  - Press **DELETE** to delete a digit.
  - Press and hold **DELETE** to delete all digits.
5. Press **SELECT** to confirm. You hear a confirmation tone.

## NOTE

- If, in the future, your telephone service provider requires you to dial the area code when making a local call, or, if you move to a location that requires it, delete the home area code you have already programmed following the steps above. After you have deleted the home area code, \_\_\_\_ appears.

## Dial mode

The dial mode is preset to touch-tone dialing. If you have pulse (rotary) service, you need to change the dial mode to pulse dialing before using the telephone.

1. Press **MENU** when the handset is not in use.
2. Press ▼ or ▲ to choose **Settings**, and then press **SELECT**.
3. Press ▼ or ▲ to choose **Dial mode**, then press **SELECT**.
4. Press ▼ or ▲ to choose **Touch-tone** or **Pulse**, then press **SELECT** to confirm your selection. You hear a confirmation tone.

## Temporary tone dialing

If you have pulse (rotary) service only, you can switch from pulse to touch-tone dialing temporarily during a call. This is useful if you need to send touch-tone signals to access your telephone banking or long distance services.

1. During a call, press <sup>TO</sup><sub>NE</sub> **\*A**.
2. Use the dialing keys to enter the number. The telephone sends touch-tone signals. It automatically returns to pulse dialing mode after you end the call.



## Rename handset

1. Press **MENU** when the handset is not in use.
2. Press ▼ or ▲ to choose **Settings**, and then press **SELECT**.
3. Press ▼ or ▲ to choose **Rename handset**, then press **SELECT**.
4. Enter a desired name, then press **SELECT** to save. You hear a confirmation tone.

## Speed dial

There are two speed dial keys, **1** and **2**, on the pendant.

Use a handset to store two contacts that you may need to call them more often or right away.

## Assign or edit a speed dial entry

1. Press **MENU** when the handset is not in use.
2. Press ▼ or ▲ to scroll to **Pendant** then press **SELECT**.
3. Press ▼ or ▲ to scroll to **Memory 1** or **Memory 2** and then press **SELECT**.
4. When **MEMORY X NUMBER** displays, use the dialing keys to enter the number (up to 30 digits).
5. Press **SELECT** to move on to enter the name. The handset displays **MEMORY X NAME**.
6. Use the dialing keys to enter the name (up to 15 characters). Additional key presses show other characters of that particular key. The first character of every word is capitalized.
7. Press **SELECT** to save. The handset displays **Memory X saved** and then you hear a confirmation tone.

### While entering names and numbers, you can:

- Press **DELETE** to backspace and erase a digit or character.
- Press and hold **DELETE** to erase the entire entry.
- Press ▼ or ▲ to move the cursor to the left or right.
- Press and hold **PAUSE** to insert a dialing pause (for entering numbers only).
- Press **0** to add a space (for entering names only).

## Dial a speed dial number

- Press **1** or **2** on the pendant to dial the corresponding speed dial number.



## Telephone operations

Handset control key panel:



## Make a call

### To make a call on a handset:

- Press  or , and then dial the telephone number.

#### NOTES

- The screen shows the elapsed time as you talk (in hours, minutes and seconds).
- While entering numbers, press and hold PAUSE to insert a dialing pause (a **P** appears).

### To make a call on a pendant:

- Press **1** or **2** to dial the corresponding speed dial number.

## Predial a call

### To predial a call on a handset:

- Enter the telephone number using the dialing keys (**0-9**), then press  to dial.

#### NOTE

- When predialing (preview numbers before dialing), press **DELETE** or **CANCEL** to backspace and delete; press and hold PAUSE to insert a dialing pause (a **P** appears).

## Answer a call

### To answer a call on a handset:

- Press  or any of the dialing key.

### To answer a call on a pendant:

- Press .

## End a call:

### To end a call on a handset:

- Press **OFF** or place the handset back in the telephone base or charger.

### To end a call on a pendant:

- Press  or place the pendant back in the pendant charger.

## Speakerphone

During a call, press ) to switch between speakerphone and normal handset use.

When the speakerphone is active, the handset displays **Speaker** and the  light turns on.

## Volume

- During a call, press **VOL-** or **VOL+** to adjust the listening volume.

## Equalizer

The equalizer enables you to change the quality of the audio for both handset earpiece and speakerphone to best suit your hearing. The default setting is **Natural**.

1. Press **MENU** during a call.
2. Press **SELECT** to choose **Equalizer**.
3. Press **▼** or **▲** to choose **Natural**, **Treble 1**, **Treble 2** or **Bass**, then press **SELECT** to save.

#### NOTES

- If you switch the call between the handset and the speakerphone by pressing ) , the audio setting remains unchanged.
- The current equalizer setting remains unchanged until a new setting is selected.

## Audio Assist®

Use the audio assist feature to enhance the clarity and loudness of the voice on the cordless handset earpiece or the telephone base speakerphone.

### To turn on Audio Assist® on the handset:

- While you are on a call using the handset earpiece, press **AUDIO ASSIST** on the handset. The handset briefly displays **Audio assist on**, and **AUDIO ASSIST** appears.
- Press **AUDIO ASSIST** again to turn off. The handset briefly displays **Audio assist off**.

### To turn on Audio Assist® on the telephone base:

- During message playback, press **Audio Assist** on the telephone base. The telephone base message window briefly displays **Ao**.
- Press **Audio Assist** again to turn off. The telephone base message window briefly displays **AF**.

## Mute

The mute function allows you to hear the other party but the other party cannot hear you.

- During a call, press **MUTE**. The handset displays **Muted** briefly and **MUTE** icon until the mute function is turned off.
- Press **MUTE** again to resume the conversation. The handset displays **Microphone ON** briefly.

Audio Assist® is a registered trademark of Advanced American Telephones.

## Join a call in progress

You can use up to four handsets and pendants at a time on an outside call.

### To join a call with a handset:

- When a handset is already on a call, press **TALK** or **CALL** to join the call.
- To exit the call, press **OFF** or place the handset in the telephone base or charger.

### To join a call on a pendant:

- Press **CALL** to join a call.
- To exit the call, press **CALL** or place the pendant in the pendant charger.

## Call waiting

When you subscribe to call waiting service from your telephone service provider, you hear an alert tone if there is an incoming call while you are already on a call.

- Press **FLASH** to put the current call on hold and take the new call.
- Press **FLASH** at any time to switch back and forth between calls.

If you also subscribe to caller ID service, it will let you see the name and telephone number of the caller during call waiting.

It may be necessary to change your telephone service to use this feature. Contact your telephone service provide if:

- You have both caller ID and call waiting, but as separate service (you may need to combine these service);
- You have only caller ID service, or only call waiting service; or
- You do not subscribe to caller ID or call waiting services.

There are fees for caller ID services. In addition, services may not be available in all areas.

## Chain dialing

Use this feature to initiate a dialing sequence from numbers stored in the phonebook, caller ID log or redial while you are on a call.

Chain dialing can be useful if you wish to access other numbers (such as bank account numbers or access codes) from the phonebook, caller ID log or redial list.

### To access a number in the phonebook while on a call:

1. Press **MENU** and then press ▼ or ▲ to select **Phonebook**.
2. Press **SELECT** and then press ▼ or ▲ to scroll to the desired entry.
3. Press **SELECT** to dial the displayed number.

### To access a number in the caller ID log while on a call:

1. Press **MENU** and then press ▼ or ▲ to select **Caller ID log**.
2. Press **SELECT** and then press ▼ or ▲ to scroll to the desired entry.
3. Press **SELECT** to dial the displayed number.

### To access a number in the redial list while on a call:

1. Press **REDIAL**.
2. Press ▼, ▲ or **REDIAL** repeatedly to browse to the desired entry.
3. Press **SELECT** to dial the displayed number.

#### NOTE

- Press **CANCEL** to exit redial, phonebook or caller ID log when you are on a call.



## Transfer a call

While on an outside call, you can transfer the call from one handset to another system device.

1. During a call, press **MENU**.
2. Press ▼ or ▲ to choose **Transfer** and then press **SELECT**.
  - If you have two or more handsets and pendants, your handset displays **TRANSFER TO:**. Press ▼ or ▲ to choose a desired device and then press **SELECT**.  
You may also enter a destination handset number (1-9), or enter <sup>PHONE</sup><sub>a>A</sub> \* followed by 0-2 for **HANDSET 10** to **HANDSET 12**, or <sup>PHONE</sup><sub>a>A</sub> \* followed by # for all devices.

The outside call is put on hold and the handset shows **Transferring call...** or **Transferring call to all...**

The destination device rings and displays **Transferring from HANDSET X**.

3. To answer on the destination handset, press  ,  or any dialing key.  
**-OR-**  
To answer the call on the pendant, press .

#### NOTES

- If the destination device does not answer the call within 30 seconds, the originating device displays **No response to transfer**. The call will be reverted to the originating device.
- If the destination device is in use, in the phonebook or caller ID log, not powered or out of range, the originating device displays **No answer. Try again.** and then reconnects to the outside call.





## Find handset and pendant

Use this feature to find all system handsets and pendants.

### To start paging:

- Press /FIND HANDSET on the right side of the telephone base when not in use. All idle handsets and pendants ring, and the handsets display **\*\* Paging \*\***.

### To end paging:

- Press /FIND HANDSET at the telephone base.
- OR-**
- Press  , **OFF**,  or any of the dialing key on the handset, or place the handset in the telephone base or charger.

**-OR-**

- Press  on the pendant.



### NOTE

- Press **MUTE** on a handset or press **VOL-** on a pendant to turn off the ringer temporarily. Paging tone continues on the other handset and pendant.





## Redial list

Each handset stores the last 10 telephone numbers dialed. Entries are shown in reverse chronological order. When there are already 10 entries, the oldest entry is deleted to make room for the new entry.





### Review a redial list entry

1. Press **REDIAL** when the handset is not in use.
2. Press ,  or **REDIAL** repeatedly until the desired entry displays.



### Dial a redial list entry

1. Press **REDIAL** when the phone is not in use.
2. Press ,  or **REDIAL** repeatedly until the desired entry displays.
3. Press  or  to dial.

**-OR-**

1. Press  or  when the phone is not in use.
2. Press **REDIAL** and then press ,  or **REDIAL** repeatedly until the desired entry displays.
3. Press **SELECT** to dial.

### Delete a redial list entry

1. Press **REDIAL** when the handset is not in use.
2. Press ,  or **REDIAL** repeatedly to browse to the desired entry.
3. Press **DELETE** to delete the displayed number. You hear a confirmation tone.

# Multiple handset use

## Intercom



Use the intercom feature for conversations between two system devices.

### NOTE

- Your telephone base supports up to 12 handsets and/or pendants. You can buy additional expansion handsets (**SN6107**) or expansion pendants (**SN6166/SN6167**) for this telephone base.

1. Press **MENU**, then press ▼ or ▲ to scroll to **Intercom** and then press **SELECT**.
  - If you have a handset and a pendant, the handset displays **Calling all pendants**. The pendant rings.
  - If you have only two handsets, the handset displays **Calling other handset**. The other handset rings and shows **Other handset is calling**.
  - If you have three or more handsets and pendant, your handset displays **INTERCOM TO:.** Press ▼ or ▲ to choose a desired device and then press **SELECT**. You may also enter a destination handset number (1-9), or enter <sup>tone</sup><sub>a>A</sub> **X** followed by **0-2** for **HANDSET 10** to **HANDSET 12**, or <sup>tone</sup><sub>a>A</sub> **X** followed by **#** for all devices.

The destination device rings.  
The destination handset displays **HANDSET X is calling** or **HANDSET X is calling all**.

2. To answer the intercom call on the destination handset, press  or any dialing key. Both handsets now display **Intercom**.  
**-OR-**  
To answer the call on the pendant, press .
3. To end the intercom call, press **OFF** or place the handset back in the telephone base or charger. Both handsets now display **Intercom ended**.  
**-OR-**  
To end the intercom call on the pendant, press  or place the pendant back in the pendant charger.

### NOTES

- To cancel the intercom call before it is answered, press **CANCEL**.
- Press **OFF**, **MUTE** or <sup>quiet</sup>**#** on the cordless handset to temporarily silence the intercom ringer.
- If the destination device is not powered, out of range, on a call, or does not answer the intercom call within 100 seconds, your handset displays **No answer. Try again.** and then returns to idle mode.
- Only one intercom call can be established at a time.

## Answer an incoming call during an intercom call



When you receive an outside call during an intercom call, there is an alert tone.

- To answer the outside call, press . The intercom call ends automatically.
- To end the intercom call without answering the outside call, press **OFF**. The telephone continues to ring.

## Call transfer using intercom

Use the intercom feature to transfer an outside call to another system handset.

1. During a call, press **MENU**, then press ▼ or ▲ to scroll to **Intercom** and then press **SELECT**.
  - If you have a handset and a pendant, the handset displays **Calling all pendants**. The pendant rings.
  - If you have only two handsets, the handset displays **Calling other handset**. The other handset rings and shows **Other handset is calling**.
  - If you have three or more handsets and pendant, your handset displays **INTERCOM TO:**. Press ▼ or ▲ to choose a desired device and then press **SELECT**. You may also enter a destination handset number (1-9), or enter <sup>PHONE</sup><sub>a>A</sub> \* followed by **0-2** for **HANDSET 10** to **HANDSET 12**, or <sup>PHONE</sup><sub>a>A</sub> \* followed by # for all devices.

The destination device rings.  
The destination handset displays **HANDSET X is calling** or **HANDSET X is calling all**.
2. To answer the intercom call on the destination handset, press <sup>TALK</sup><sub>TALK</sub>,  or any dialing key. Both handsets now display **Intercom**.  
**-OR-**  
To answer the call on the pendant, press .

## NOTES

- To cancel the intercom call before it is answered, press **CANCEL**.
  - If the destination device is not powered, out of range, on a call, or does not answer the intercom call within 100 seconds, your handset displays **No answer. Try again.** and then returns to idle mode.
3. For this intercom call, you have the following options:
    - You can let the destination handset join you on the outside call in a three-way conversation. Press **MENU**, then press ▼ or ▲ to scroll to **Share call** and then press **SELECT** on the originating handset.
    - You can transfer the call. Press **MENU**, then press **SELECT**. Your handset displays **Call transferred**. The destination device is then connected to the outside call.
    - You can end the intercom call and continue the outside call with the originating handset. Press <sup>TALK</sup><sub>TALK</sub> on your handset, or the other party can press **OFF** on the handset, or place the handset back in the telephone base.

# Phonebook

The phonebook can store up to 50 entries, which are shared by all handsets. Each entry may consist of a telephone number up to 30 digits, and a name up to 15 characters.

Any additions, deletions or edits made on one handset are not reflected on other handsets.

If the telephone number in the phonebook exceeds 15 digits, a dash appears after the 14th digit and then the remaining digits are shown beginning with a dash, alternately.

## Add a phonebook entry

1. Enter the number when the phone is not in use. Press **SELECT**, then go to Step 3.

**-OR-**

Press **MENU** when the phone is not in use, then press ▼ or ▲ to scroll to **Phonebook** and press **SELECT**. Press ▼ or ▲ to scroll to **Add contact**, and then press **SELECT**.

2. When **ENTER NUMBER** displays, use the dialing keys to enter the number.

**-OR-**

Copy a number from the redial list by pressing **REDIAL** and then press ▼, ▲ or **REDIAL** repeatedly to select a number. Press **SELECT** to copy the number.

3. Press **SELECT** to move on to enter the name. The handset displays **ENTER NAME**.

4. Use the dialing keys to enter the name. Additional key presses show other characters of that particular key. The first character of every word is capitalized.
5. Press **SELECT** to save. The handset displays **Saved** and then you hear a confirmation tone.

## While entering names and numbers, you can:

- Press **DELETE** to backspace and erase a digit or character.
- Press and hold **DELETE** to erase the entire entry.
- Press ▼ or ▲ to move the cursor to the left or right.
- Press and hold **PAUSE** to insert a dialing pause (for entering numbers only).
- Press **0** to add a space (for entering names only).

## Review a phonebook entry

Entries are sorted alphabetically.

1. Press  when the phone is not in use.
2. Press ▼ or ▲ to browse through the phonebook, or use the dialing keys to start a name search.

**-OR-**

1. Press **MENU** when the phone is not in use.
2. Press ▼ or ▲ to scroll to **Phonebook** then press **SELECT** twice.
3. Press ▼ or ▲ to browse.

## Alphabetical search

1. Follow the steps in **Review a phonebook entry** above to enter the phonebook.
2. Use the dialing keys to enter the letter associated with the name. For example, if you have entries for Jenny, Jessie, Kristen and Laura in your phonebook, press **5** (JKL) once to see Jenny (when **Jenny** displays, press ▼ to see Jessie), twice to see Kristen, or three times to see Laura. If there is no name entry matching your search, the next closest match in alphabetical order appears. If necessary, press ▼ or ▲ to browse.



## Delete a phonebook entry

1. Search for the desired entry in the phonebook (see **Review a phonebook entry** or **Alphabetical search**).
2. When the desired entry appears, press **DELETE**. The handset displays **Delete contact?** and the number.
3. Press **SELECT** to confirm. The handset displays **Contact deleted**. You hear a confirmation tone.

## Edit a phonebook entry

1. Search for the desired entry in the phonebook (see **Review a phonebook entry** or **Alphabetical search**).
2. When the desired entry appears, press **SELECT**. The handset displays **EDIT NUMBER** and the stored number.
3. Use the dialing keys to edit the number, then press **SELECT**. The handset displays **EDIT NAME** and then the stored name.
4. Use the dialing keys to edit the name. Additional key presses show other characters of that particular key. The first character of every word is capitalized.
5. Press **SELECT** to save. The handset displays **Saved** and then you hear a confirmation tone.

## Dial a phonebook entry

1. Search for the desired entry in the phonebook (see **Review a phonebook entry** or **Alphabetical search**).
2. When the desired entry appears, press  or  to dial.

## Caller ID

If you subscribe to caller ID service, information about each caller appears after the first or second ring. If you answer a call before the caller information appears on the screen, it will not be saved in the caller ID log.

The caller ID log stores up to 50 entries. Each entry has up to 24 digits for the phone number and 15 characters for the name.

If the telephone number has more than 15 digits, only the last 15 digits appear. If the name has more than 15 characters, only the first 15 characters are shown and saved in the caller ID log.

Entries appear in reverse chronological order. When the caller ID log is full, the oldest entry is deleted to make room for new incoming call information.

Caller ID log entries are shared by all system handsets. Any deletions made on one handset are reflected on all other handsets.

### NOTE

- This product can provide information only if both you and the caller are in areas offering caller ID service and if both telephone service providers use compatible equipment. The time and date are sent by your telephone service provider along with the call information.

## Review a caller ID log entry

1. Press **CID** when the phone is not in use.
2. Press **▼** or **▲** to browse through the caller ID log.

## -OR-

1. Press **MENU** when the phone is not in use. Press **▼** or **▲** to select **Caller ID log**.
2. Press **SELECT** twice and then press **▼** or **▲** to browse.

## Memory match

When the incoming telephone number matches the last seven digits of a telephone number in your phonebook, the screen displays the stored name of the phonebook entry.

For example, if Linda Jones calls, her name appears as **Linda** if this is how you entered it into your phonebook.

### NOTE

- The number shown in the caller ID log is in the format sent by the telephone service provider. It usually delivers 10-digit telephone numbers (area code plus phone number). If the last seven digits of the incoming telephone number does not match a number in your phonebook, the name appears as it is delivered by the telephone service provider.

## Missed call indicator

When there are calls that have not been reviewed in the caller ID log, the handset displays **XX Missed calls**.

Each time you review a caller ID log entry marked **NEW**, the number of missed calls decreases by one.

When you have reviewed all the missed calls, the missed call indicator no longer displays.

If you do not want to review the missed calls one by one, press and hold **CANCEL** or **DELETE** on the idle handset to erase the missed call indicator. All the entries are then considered old.



## View dialing options

Although the caller ID log entries received have 10 digits (the area code plus the seven-digit number), in some areas, you may dial only the seven digits, or a 1 plus the seven digits, or a 1 plus the area code plus the seven digits. You can change the number of digits that you dial from or store to the phonebook.

While reviewing the caller ID log, press **QUIET #** repeatedly to show different dialing options for local and long distance numbers before dialing or saving the telephone number in the phonebook.

Press **☒ 1** repeatedly if you need to add or remove 1 in front of the telephone number before dialing or saving it in the phonebook.

→ Press # → 1-800-595-9511  
→ Press # → 595-9511  
→ Press # → 1-595-9511  
→ Press # → 800-595-9511  
-OR-  
→ Press 1 → 1-800-595-9511  
→ Press 1 → 800-595-9511

### NOTE

- If you have programmed the home area code, only the last seven digits of the incoming phone numbers from that area code will be displayed while reviewing the caller ID log. Press **QUIET #** repeatedly to display all possible dialing options.

## Dial a caller ID log entry

When the number is shown in the correct format for dialing, press **TALK** or **📞** to dial.

## Save a caller ID log entry to the phonebook

1. When in the caller ID log, press **▼** or **▲** to browse.
2. When the desired caller ID log entry displays, press **SELECT**. The handset displays **EDIT NUMBER** and the stored number.

3. Use the dialing keys to modify the number, if necessary. Then press **SELECT**. The handset displays **EDIT NAME** and then the stored name.
4. Use the dialing keys to modify the name, if necessary. Then press **SELECT**. The handset displays **Saved** and then you hear a confirmation tone.

### While entering names and numbers, you can:

- Press **DELETE** to backspace and erase a digit or character.
- Press and hold **DELETE** to erase the entire entry.
- Press **▼** or **▲** to move the cursor to the left or right.
- Press and hold **PAUSE** to insert a dialing pause (for entering numbers only).
- Press **0** to add a space (for entering names only).

## Delete the caller ID log entries

1. When in the caller ID log, press **▼** or **▲** to browse.
2. When the desired caller ID log entry displays, press **DELETE**. You hear a confirmation tone.

### To delete all caller ID log entries:

1. Press **MENU** when the phone is not in use.
2. Press **▼** or **▲** to select **Caller ID log** and then press **SELECT**.
3. Press **▼** or **▲** to select **Del all calls** then press **SELECT**.
4. The screen displays **Delete all calls?**. Press **SELECT** to confirm. You hear a confirmation tone.

# Sound settings

## Quiet mode

You can turn on the quiet mode for a period of time (1-12 hours). During this period, all tones (except paging tone) and call screening are muted.

When you turn on the quiet mode, the answering system turns on automatically. When the quiet mode duration expires, the answering system remains on.

### To set the duration and turn on the quiet mode:

1. Press and hold **QUIET#** when the handset is not in use.
2. The handset displays **Quiet: \_\_ hours**. Use the dialing keys (0-9) to enter the desired duration (1-12).
3. Press **SELECT** to save. You hear a confirmation tone.

The handset displays **Answering sys is ON** briefly, and then **Quiet mode on** and . The **ANS ON/OFF** light on the telephone base turns on.

#### NOTE

- When you change the settings of the ringer tone, handset ringer volume or telephone base ringer volume, you can still hear the samples even if the quiet mode is on.

### To turn off the quiet mode:

- Press and hold **QUIET#** when the handset is not in use. The handset displays **Quiet mode off** briefly and then returns to idle.

## Key tone

You can turn the key tone on or off for each handset.

1. Press **MENU** when the handset is not in use.
2. Press **▼** or **▲** to choose **Settings** and then press **SELECT**.
3. Press **▼** or **▲** to choose **Key tone**, then press **SELECT**.
4. Press **▼** or **▲** to sample each volume level, then press **SELECT** to save. You hear a confirmation tone.

## Handset ringer tone

You can choose from different ringer tones for each handset.

1. Press **MENU** when the handset is not in use.
2. Press **▼** or **▲** to choose **Ringers** and then press **SELECT**.
3. Press **▼** or **▲** to choose **Ringer tone**, then press **SELECT**.
4. Press **▼** or **▲** to sample each ringer tone.
5. Press **SELECT** to save. You hear a confirmation tone.

#### NOTE

- If you turn off the ringer volume, you will not hear ringer tone samples.

## Pendant ringer tone

You can choose from different ringer tones for pendant.

1. Press **MENU** when the handset is not in use.
2. Press **▼** or **▲** to choose **Pendant** and then press **SELECT**.
3. Press **▼** or **▲** to choose **Pendant Ringer**, then press **SELECT**.
4. Press **▼** or **▲** to sample each ringer tone.
5. Press **SELECT** to save. You hear a confirmation tone.

## Telephone base ringer volume

Press **▲VOL** or **▼VOL** on the telephone base to adjust the ringer volume when the telephone base is not in use.

When you set the ringer volume to zero, the base ringer is off. The telephone base announces, “*Base ringer is off.*”

## Handset ringer volume

You can adjust the handset ringer volume level, or turn the ringer off.

If you turn the ringer off, the caller ID will not be announced.

1. Press **MENU** when the handset is not in use.
2. Press **▼** or **▲** to choose **Ringers** and then press **SELECT** twice.
3. Press **▼** or **▲** to sample each ringer volume level.
4. Press **SELECT** to save. You hear a confirmation tone.

**-OR-**

Press **VOL+** or **VOL-** when the handset base is not in use.

## NOTES

- If the ringer volume is set to **Off**, the idle screen displays  and **Ringer off**.
- When the ringer volume is set to **Off**, the handset still rings when you press **FIND HANDSET** at the telephone base.

## Pendant ringer volume

Press **VOL+** or **VOL-** when the pendant is not in use.

When the pendant ringer is set to off, you hear two beeps.

## NOTE

- When the ringer volume is set to off, the pendant still rings when you press **FIND HANDSET** at the telephone base.

## Temporary ringer silencing

When the telephone is ringing, you can temporarily silence the ringer without disconnecting the call. The next call rings normally at the preset volume.

### To silence the handset ringer:

- Press **MUTE**, **CANCEL** or **QUIET**. The handset displays  and **Ringer muted**.

### To silence the pendant ringer:

- Press **VOL-**.

## Reminder

The reminder feature helps remind you of important events. You can set the reminder to remind you only once, or in daily, weekly or monthly bases.

Once you set the reminder, the system will alarm you at the alarm time and every 15 minutes after the alarm time for three more times.

### Turn the reminder on or off

1. Press **MENU** when the handset is not in use.
2. Press ▼ or ▲ to choose **Reminder** and then press **SELECT**.
3. Press ▼ or ▲ to choose **On/Off** and then press **SELECT**.
4. Press ▼ or ▲ to choose **On** or **Off** and then press **SELECT** to save. You hear a confirmation tone.

#### NOTE

- When the reminder feature is set to off, it will be automatically turned on after a reminder is recorded. The handset displays **Reminder is turned ON**.

## Add a reminder

Each reminder can be up to four minutes in length. The total storage capacity for the announcement, messages, memos and reminders is approximately 14 minutes.

1. Press **MENU** when the handset is not in use.
2. Press ▼ or ▲ to choose **Reminder** and then press **SELECT**.
3. Press ▼ or ▲ to choose **Set reminder** and then press **SELECT**.
4. Use the dialing keys (**0-9**) to enter the month (**MM**), date (**DD**) and year (**YY**). Then press **SELECT**.
5. Use the dialing keys (**0-9**) to enter the hour (**HH**) and minute (**MM**). Then press ▼ or ▲ to choose **AM** or **PM**. Then press **SELECT**.
6. The system announces, “*Record after the tone. Press 5 when you are done.*” After the tone, speak towards the microphone.
7. Press **5** when done. The system announces, “*Recorded.*”
8. Press ▼ or ▲ to scroll to the frequency you would like to set, then press **SELECT**. You hear a confirmation tone.
  - **Once** Reminder occurs only once at the specific time and date you set.
  - **Daily** Reminder occurs every day at the specific time you set.
  - **Weekly** Reminder occurs every week at the specific time and day you set.
  - **Monthly** Reminder occurs every month at the specific time and date you set.

## Review reminders

When playback begins, the total number of reminders is announced. Before each reminder, you hear the day and time of the recording. After the last reminder, the handset displays **End of reminder** and you hear, “*End of reminder.*”

1. Press **MENU** when the handset is not in use.
2. Press **▼** or **▲** to choose **Reminder** then press **SELECT**.
3. Press **SELECT** to select **Review**. The reminders play automatically.

### Options during playback:

- Press **VOL+** or **VOL-** to adjust the reminder playback volume.
- Press **4** to repeat the current reminder.
- Press **5** to stop playback.
- Press **6** to skip to the next reminder.
- Press **🔊** to switch between the speakerphone and the handset earpiece.
- Press **DELETE** to delete the current reminder. The handset displays **Reminder deleted**. The system announces, “*Reminder deleted.*”

## Add and review reminders remotely

You can also add or review reminders remotely from any touch-tone telephone. See **Remote access** for more information.

## About the built-in answering system and voicemail service

For message recording, your telephone has a built-in answering system, and it also supports voicemail service offered by your telephone service provider (subscription is required, and fee may apply).

The main differences between them are:

Category	Built-in answering system	Voicemail from telephone service
Storage	Messages are stored in the telephone base.	Messages are stored in a server or system provided by your telephone service provider.
	Your messages will not be deleted automatically. You have to delete your messages manually.	Your messages may be automatically deleted after a period of time. Contact your telephone service provider for more details.
Method to retrieve messages	When you received new messages, the handset displays <b>XX New messages</b> , and the message window on the telephone base flashes.	When you received new messages, the handset displays <b>📧</b> and <b>New voicemail</b> .

<p>Method to retrieve messages</p>	<p>To retrieve messages, usually there are two ways:</p> <ul style="list-style-type: none"> <li>• Press ►/■ on the telephone base; or</li> <li>• Access remotely with an access code.</li> </ul>	<p>To retrieve messages, you need an access number and/ or a passcode provided by your telephone service provider.</p>
------------------------------------	--	--

## Set your built-in answering system

The answering system can record and store up to 99 messages. Each message can be up to three minutes in length. The total storage capacity for the announcement, messages and memos is approximately 14 minutes. The actual recording time depends on individual message characteristics.

Your answering system allows you to set your announcement, to save and delete messages, activate call screening, to set number of rings before pick up, to access remotely, and to control the recording time.

Telephone base control key panel:

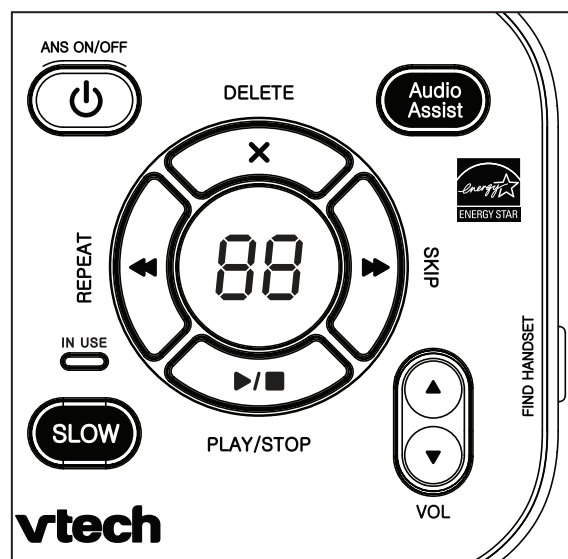

### Turn the answering system on or off

The answering system must be turned on to answer and record messages.

When the answering system is turned on, the **⏻/ANS ON/OFF** light on the telephone base turns on and **ANS ON** displays on the handset.

### To turn on or off with the telephone base:

- Press **⏻/ANS ON/OFF** to turn the built-in answering system on or off. When the answering system is turned on, it announces, *“Calls will be answered.”* When the answering system is turned off, it announces, *“Calls will not be answered.”*



## To turn on or off with the handset:

1. Press **MENU** when the phone is not in use.
2. Press ▼ or ▲ to choose **Answering sys** and then press **SELECT**.
3. Press ▼ or ▲ to choose **Answer ON/OFF** and then press **SELECT**.
4. Press ▼ or ▲ to choose **On** or **Off** and then press **SELECT** to save.  
You hear a confirmation tone.

## Default announcement

The telephone is preset with a greeting that answers calls with “*Hello, please leave a message after the tone.*” You can use this preset announcement, or replace it with your own.

## Record your own announcement

The announcement can be up to 90 seconds in length.

1. Press **MENU** when the phone is not in use.
2. Press ▼ or ▲ to choose **Answering sys** then press **SELECT**.
3. Press **SELECT** to select **Announcement**.
4. Press **SELECT** to select **Record annc**.
5. The handset announces, “*Record after the tone. Press 5 when you are done.*” After the tone, speak towards the handset microphone.
6. Press **5** when finished. The handset plays back the recorded announcement.

### NOTE

- Announcements shorter than two seconds will not be recorded.

## Play the announcement

1. Press **MENU** when the phone is not in use.
2. Press ▼ or ▲ to choose **Answering sys** then press **SELECT**.
3. Press **SELECT** to select **Announcement**.
4. Press ▼ or ▲ to choose **Play annc** then press **SELECT**.

### Options during playback:

- Press **VOL+** or **VOL-** to adjust the listening volume.
- Press **5** or **OFF** to stop at any time.
- Press  to switch between the speakerphone and the handset earpiece.

## Delete the announcement

1. Press **MENU** when the phone is not in use.
2. Press ▼ or ▲ to choose **Answering sys** then press **SELECT**.
3. Press **SELECT** to select **Announcement**.
4. Press ▼ or ▲ to choose **Play annc** then press **SELECT**.
5. While it plays the announcement, press **DELETE**. The handset displays **Annc. Deleted**, and the system announces, “*Announcement deleted.*”

### NOTE

- After you deleted your own recorded announcement, the answering system answers calls with the default announcement.

## Set number of rings

You can set the answering system to answer an incoming call after two, three, four, five or six rings; or toll saver.

If you choose toll saver, the answering system answers a call after two rings when you have new messages, or after four rings when you have no new messages. This enables you to check for new messages and avoid paying unnecessary long distance charges if you are calling from outside your local area.

1. Press **MENU** when the phone is not in use.
2. Press ▼ or ▲ to choose **Answering sys** and then press **SELECT**.
3. Press ▼ or ▲ to choose **Ans sys setup** and then press **SELECT**.
4. Press ▼ or ▲ to choose **# of rings** and then press **SELECT**.
5. Press ▼ or ▲ to choose **6, 5, 4, 3, 2** or **Toll saver** and then press **SELECT** to save. You hear a confirmation tone.

## Set recording time

You can set the recording time for each incoming message.

1. Press **MENU** when the phone is not in use.
2. Press ▼ or ▲ to choose **Answering sys** and then press **SELECT**.
3. Press ▼ or ▲ to choose **Ans sys setup** and then press **SELECT**.
4. Press ▼ or ▲ to choose **Recording time** and then press **SELECT**.
5. Press ▼ or ▲ to choose **3 minutes, 2 minutes** or **1 minute**, and then press **SELECT** to save. You hear a confirmation tone.

## Turn the call screening on or off

You can hear incoming messages at the telephone base while they are being recorded.

1. Press **MENU** when the phone is not in use.
2. Press ▼ or ▲ to choose **Answering sys** and then press **SELECT**.
3. Press ▼ or ▲ to choose **Ans sys setup** and then press **SELECT**.
4. Press **SELECT** to select **Call screening**.
5. Press ▼ or ▲ to choose **On** or **Off**, and then press **SELECT** to save. You hear a confirmation tone.

## Turn the message alert tone on or off

When the message alert tone is set to on, and there is at least one new message, the telephone base beeps every 10 seconds.

1. Press **MENU** when the phone is not in use.
2. Press ▼ or ▲ to choose **Answering sys** and then press **SELECT**.
3. Press ▼ or ▲ to choose **Ans sys setup** and then press **SELECT**.
4. Press ▼ or ▲ to choose **Msg alert tone**, and then press **SELECT**.
5. Press ▼ or ▲ to choose **On** or **Off**, and then press **SELECT** to save. You hear a confirmation tone.

### NOTES

- The answering system must be turned on for the message alert tone to be functional.
- Press any key on the telephone base (except **⏏/FIND HANDSET**) to temporarily silence the message alert tone.

# Use your built-in answering system

## New message indication

When there are new answering system messages, the handset displays **XX New messages**, and the message window on the telephone base flashes. When you are reviewing a new message, **NEW** displays on the handset.

Message window display	Description
0	No messages.
1-99	Total number of old messages and memos recorded. The message number currently playing.
0-99 (flashing)	Total number of new messages recorded, or the current message number during new message playback. The clock needs to be set.
1-99 & F (alternating)	The answering system memory is full with total number of messages recorded.
1-8	The telephone base speaker volume level while adjusting.
0-6	The telephone base ringer level while adjusting.
.....	The answering system is answering a call, or recording a memo or announcement. The handset is on a call, or in the caller ID log. The answering system is being accessed remotely.

If the message alert tone is turned on, the telephone base beeps every 10 seconds when there are messages that have not been reviewed.

## Message playback

If you have new messages, the telephone plays only the new messages (oldest first). If there are no new messages, the telephone plays back all messages (oldest first).

When playback begins, you hear the total number of messages followed by the date and time of the message. After the last message, the telephone announces, “*End of messages.*”

### NOTE

- Make sure you set the date and time correctly. Refer to **Set date and time** under the **Configure your telephone** section for more details.

## To playback messages at the telephone base:

- Press **▶/■/PLAY** when the phone is not in use. When you have no message in the answering system, the telephone base announces, “*You have no message.*”





## Options during playback:

- Press **▲VOL** or **▼VOL** to adjust the listening volume.
- Press **▶/■/SKIP** to skip to the next message.
- Press **◀/REPEAT** to repeat the playing message. Press **◀/REPEAT** twice to listen to the previous message.
- Press **X/DELETE** to delete the playing message. The telephone base announces, “*Message deleted,*” and then advances to the next message.
- Press **▶/■/STOP** to stop the playback.
- Press **SLOW** to reduce the playback speed.

## To playback messages with a handset:

1. Press **MENU** when the telephone is not in use.
2. Press **SELECT** to choose **Play messages**.
3. If you have only new or old messages, the messages play automatically.  
**-OR-**  
If you have both new and old messages, press ▼ or ▲ to scroll to **Play new msgs** or **Play old msgs**, then press **SELECT**.

## Options during playback:

- Press **VOL+** or **VOL-** to adjust the listening volume.
- Press  to switch between the speakerphone and the handset earpiece.
- Press **6** to skip to the next message.
- Press **4** to repeat the playing message. Press **4** twice to listen to the previous message.
- Press **DELETE** to delete the playing message. The handset announces, *"Message deleted,"* and then advances to the next message.
- Press  to call back the caller. The handset displays **Call back?**. Press **SELECT** to confirm or press **OFF** to cancel.
- Press **SELECT** to pause the playback and view the caller's information. Then you can press  or  to call back.

## Delete all messages

You can only delete old (reviewed) messages. You cannot delete new messages until you review them. You cannot retrieve deleted messages.

## To delete all messages with the telephone base:

1. Press **X/DELETE** when the phone is not in use. The system announces, *"To delete all old messages, press DELETE again."*
2. Press **X/DELETE** immediately. The system announces, *"All old messages deleted."* You hear a confirmation tone.

## To delete all messages with a handset:

1. Press **MENU** when the phone is not in use.
2. Press ▼ or ▲ to choose **Answering sys** and then press **SELECT**.
3. Press ▼ or ▲ to choose **Delete all old** and then press **SELECT**. The handset displays **Delete all old messages?**.
4. Press **SELECT** to confirm. The handset displays **Deleting...** and then **All old msgs deleted!**. You hear a confirmation tone.

## Call screening

### To screen a call at the telephone base:

If the answering system and call screening are on, the announcement and the incoming message broadcast at the telephone base while the call is answered by the answering system.

### Options while a message is being recorded:

- Press **▲VOL** or **▼VOL** to adjust the listening volume.
- Press **▶/■/STOP** to temporarily turn off the call screening.



### To screen a call at a handset:

If the answering system is on and your answering system is recording a message, press **SELECT** to screen the call on your handset. The announcement and the incoming message broadcast at the handset while the call is answered by the answering system.

### Options while a message is being recorded:

- Press **VOL+** or **VOL-** to adjust the listening volume.
- Press **OFF** to temporarily turn off the feature.
- Press **SELECT** to temporarily turn on the feature if it is set to off.

## Call intercept

If you want to talk to the person whose message is being recorded, press  or  on the handset.

## Record, play or delete memos

Memos are your own recorded messages used as reminders for yourself or others using the same answering system. You can record your own memos using a system handset. Playback and delete them in the same way as incoming messages.

1. Press **MENU** when the phone is not in use.
2. Press **▼** or **▲** to choose **Answering sys** and then press **SELECT**.
3. Press **▼** or **▲** to choose **Record memo** and then press **SELECT**. The handset announces, “*Record after the tone. Press 5 when you are done.*”
4. Speak towards the handset microphone. Press **5** when you finish recording. The handset announces “*Recorded.*”

### NOTES

- If you record a memo when the answering system memory is full, the system announces, “*Memory is full.*”
- Each memo can be up to four minutes in length. Memos shorter than two second are not recorded.

## Use the built-in answering system and voicemail service

You can use your answering system and voicemail service together by setting your answering system to answer before voicemail service answers as described below. To learn how to program your voicemail settings, contact your telephone service provider.

If you are on a call, or if the answering system is busy recording a message and you receive another call, the second caller can leave a voicemail message.

Set your answering system to answer calls at least two rings earlier than your voicemail service is set to answer.

For example, if your voicemail service answers after six rings, set your answering system to answer after four rings. Some voicemail service providers may program the delay before answering calls in seconds instead of rings. In this case, allow six seconds per ring when determining the appropriate setting.

## Retrieve voicemail from telephone service

Voicemail is a feature available from most telephone service providers. It may be included with your telephone service, or may be optional. Fees may apply.

### Retrieve voicemail

When you received a voicemail, the handset displays  and **New voicemail**. To retrieve, you typically dial an access number provided by your telephone service provider, and then enter a security code. Contact your telephone service provider for instructions on how to configure the voicemail settings and listen to messages.

#### NOTE

- After you have listened to all new voicemail messages, the indicators on the handset turn off automatically.

### Set your voicemail number

You can save your access number on each handset for easy access to your voicemail.

After you saved the voicemail number, you can press and hold  **1** to retrieve voicemail.

1. Press and hold  **1** when the handset is not in use.
2. Use the dialing keys to enter the voicemail number (up to 30 digits).
3. Press **SELECT** to save. The handset displays **Voicemail # saved**. You hear a confirmation tone.



## -OR-

1. Press **MENU** when the handset is not in use.
2. Press ▼ or ▲ to choose **Settings** and then press **SELECT**.
3. Press ▼ or ▲ to choose **Voicemail #** and then press **SELECT**.
4. Use the dialing keys to enter the voicemail number (up to 30 digits).
5. Press **SELECT** to save. The handset displays **Voicemail # saved**. You hear a confirmation tone.

### While entering numbers, you can:

- Press **DELETE** to backspace and erase a digit.
- Press and hold **DELETE** to erase the entire entry.
- Press ▼ or ▲ to move the cursor to the left or right.
- Press and hold **PAUSE** to insert a dialing pause.

## Turn off the new voicemail indicators

If you have retrieved your voicemail while away from home, and the handset still displays the new voicemail indicators, use this feature to turn off the indicators.

### NOTE

- This feature turns off the indicators only, it does not delete your voicemail messages.
1. Press **MENU** when the phone is not in use.
  2. Press ▼ or ▲ to choose **Settings** and then press **SELECT**.
  3. Press ▼ or ▲ to choose **Clr voicemail** and then press **SELECT**.
  4. The screen displays **Reset Voicemail Indicator?**. Press **SELECT** to confirm. You hear a confirmation tone.

## Remote access

A two-digit security code is required to access the reminders and answering system remotely from any touch-tone telephone. The preset code is **19**. You can use this preset code, or set your own.

### Access your reminders remotely

1. Dial your telephone number from any touch-tone telephone.
2. Enter the two-digit security code after the announcement and the long beep.
3. The system announces, “*Press star for reminder or press pound to listen to messages.*” Press **TONES** **★**.
4. Enter one of the following remote commands.

Command	Description
1	Review reminders.
2	Set reminders.
3	End the call.
4	Turn reminder off.

5. Hang up or press **3** to end the call.

### Access your answering system remotely

1. Dial your telephone number from any touch-tone telephone.
2. Enter the two-digit security code after the announcement and the long beep.
3. The system announces, “*Press star for reminder or press pound to listen to messages.*” Press **#**.

- Enter one of the following remote commands.

Command	Description
1	Play all messages.
2	Play only new messages.
3	Delete the current message (during playback).
33	Delete all old messages.
4	Repeat the current message (during playback).
5	Stop.
*5	Hear a list of remote commands.
6	Skip to the next message (during playback).
*7	Record a new announcement.
8	End the call.
0	Turn the answering system on or off.

- Hang up or press **8** to end the call.

#### NOTES

- If you do not press any key within 20 seconds, the remote access call automatically disconnects.
- When the answering system memory is full, the telephone announces, “*Memory is full. Enter the remote access code.*”
- When the answering system is turned off, the telephone answers after 10 rings, and announces, “*Please enter your remote access code.*”

## Set your remote access code

You can set your own remote access code from **00** to **99**.

- Press **MENU** when the phone is not in use.
- Press ▼ or ▲ to choose **Answering sys** and then press **SELECT**.
- Press ▼ or ▲ to choose **Ans sys setup** and then press **SELECT**.
- Press ▼ or ▲ to choose **Remote code** and then press **SELECT**.
- Press the dialing keys (**0-9**) to enter the code, or ▼ or ▲ to select from **00** to **99**, then press **SELECT** to save. You hear a confirmation tone.

## Voice command

By saying certain commands to the pendant, you can hear information such as the date or time, or call speed dial numbers, or even review call log, messages or reminders.

### Turn the voice command on or off

1. Press **MENU** when the handset is not in use.
2. Press ▼ or ▲ to choose **Pendant**, and then press **SELECT**.
3. Press ▼ or ▲ to choose **Voice command**, then press **SELECT**.
4. Press ▼ or ▲ to choose **On** or **Off**, then press **SELECT** to save. You hear a confirmation tone.

### Use the voice command

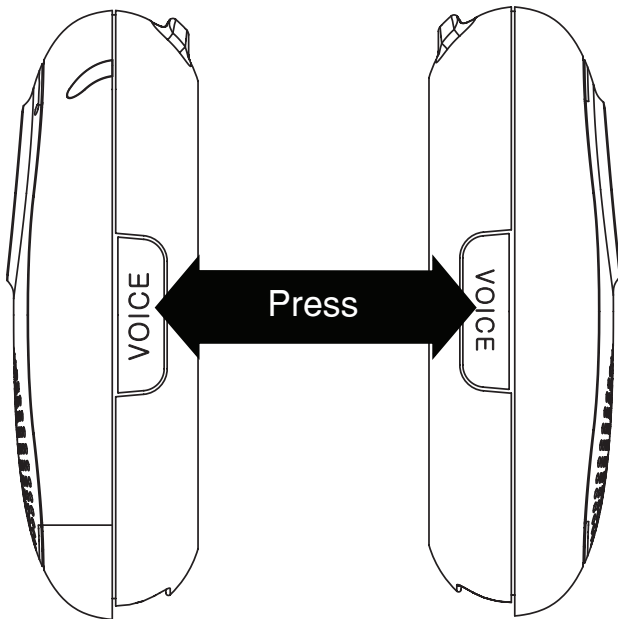

Press **VOICE** on either side of the pendant when the telephone is idle. After you hear a beep, say your command to the pendant.

### NOTE

- If you do not say the command within five seconds, or the system does not understand your command, the system will say, "Sorry, I didn't catch that. Please press the voice command button and try again."

## Common commands

Command	Description
<i>What can I say?</i>	To hear a list of voice commands.
<i>What time is it?</i>	To hear the current time.
<i>What is the date?</i>	To hear the current date.
<i>Call speed dial X.</i>	To call a speed dial number.
<i>Intercom all.</i>	To send out intercom request to all devices.
<i>Cancel.</i>	To return to idle mode.

## Commands to review reminders

Command	Description
<i>Review reminders.</i>	To review all missed reminders.
<i>What can I say?</i>	To hear a list of voice commands.
<i>Skip reminder.</i>	To skip to the next reminder.
<i>Repeat reminder.</i>	To repeat the reminder.
<i>Stop.</i>	To stop the reminder playback.
<i>Cancel.</i>	To continue the reminder playback.

## Commands to review messages

Command	Description
<i>Review messages.</i>	To review all new messages.
<i>What can I say?</i>	To hear a list of voice commands.
<i>Skip messages.</i>	To skip to the next message.
<i>Repeat messages.</i>	To repeat the message.
<i>Slow playback.</i>	To slow down the message playback.
<i>Play normal.</i>	To resume normal message playback speed.
<i>Stop.</i>	To stop the message playback.
<i>Delete.</i>	To delete the current message.
<i>Cancel.</i>	To continue the message playback.

## Commands to review caller ID log

Command	Description
<i>Review call log.</i>	To review the caller ID log.
<i>What can I say?</i>	To hear a list of voice commands.
<i>Skip call log.</i>	To skip to the next call log entry.
<i>Repeat call log.</i>	To repeat the call log entry.
<i>Stop.</i>	To stop the call log entry playback.
<i>Cancel.</i>	To continue the call log entry playback.
<i>Call back.</i>	The system will ask, "Would you like to call XXX?" <ul style="list-style-type: none"> <li>• Say "Yes" to call the number.</li> <li>• Say "No" to return to the playback.</li> </ul>

## Expand your telephone system

You can add new handsets (**SN6107**, purchased separately) and new pendants (**SN6166/SN6167**, purchased separately) to your telephone system. Your telephone base supports a maximum of 12 devices.

Additional handsets are assigned numbers in the sequential order.

### Add and register a handset

Charge the new handset without interruption for at least 30 minutes before registering it to the telephone base.

After charged, each expansion handset displays **To register HS, see manual.**

#### NOTES

- You cannot register a handset if any other system handset is in use.
- Only one handset can register to the telephone base at a time.

### To register a handset:

- Place the new or non-registered handset in the telephone base. The handset displays **Registering... Please wait.**

The handset show **Registered** and you hear a beep when the registration process completes. The registration process takes about 60 seconds to complete.

If the registration fails, the handset displays **Registration failed**, and then **To register HS, see manual.** Remove the handset from the telephone base and repeat the registration process again.

## Add and register a pendant

Charge the new pendant without interruption for at least 30 minutes before registering it to the telephone base.

You hear three beeps every 10 seconds when the pendant is not registered.

### NOTES

- You cannot register a handset if any other system handset is in use.
- Only one handset can register to the telephone base at a time.

### To register a pendant:

Make sure the pendant is out of the pendant charger and turned on.

1. Press and hold /FIND HANDSET at the telephone base until the **IN USE** light turns red.
2. Put the pendant in the pendant charger. The pendant status light flashes red and green to indicate the registration is in progress.

The pendant beeps when the registration process completes. The registration process takes about 60 seconds to complete.

If registration fails, you hear an error tone. Remove the pendant from the pendant charger and repeat the registration process again.

## Deregister all devices



To replace a device or reassign the designated handset number of a registered handset, you must deregister all devices, and then register each device individually.

### NOTES

- You cannot deregister all devices if any other system device is in use.
- If deregistration fails, reset the system and try again. To reset, unplug the power from the telephone base and plug it back in.
- Even if your devices have run out of battery, you can still deregister them by following the instructions in this section.

### To deregister all handsets:

Make sure no handset is put in the telephone base before deregistration.

1. Press and hold /FIND HANDSET at the telephone base for about 10 seconds until the **IN USE** light turns red and starts to flash.
2. Press /FIND HANDSET immediately again. You hear a confirmation tone.

All handsets display **To register HS**, see **manual** when the deregistration process completes. The deregistration process takes about 10 seconds to complete.

## Other information

### Website

Use this feature to view the VTech website address.

1. Press **MENU** when the handset is not in use.
2. Press ▼ or ▲ to choose **Web address** and then press **SELECT**. The screen displays the VTech website address.

## Screen messages

Caller ID log empty	There are no caller ID log entries.
Calling all devices (for models with two or more devices only)	The handset is calling all devices (for intercom calls).
Calling HS X (for models with two or more devices only)	The handset is calling another handset (for intercom calls). The handset is transferring an outside call to another handset.
Calls will be answered	The answering system is turned on and will answer calls.
Calls will not be answered	The answering system is turned off and will not answer calls.
Contact deleted	A phonebook entry is deleted.
Ended	You have just ended a call.
HANDSET X is calling (for models with two or more handsets only)	Another handset is calling (for intercom calls).
Incoming call	There is an incoming call.
Intercom	The handset is on an intercom call.
Intercom ended	The intercom call has just ended.
INTERCOM TO: (for models with three or more handsets only)	You have started the intercom process, and need to enter the number of the handset you wish to call.



Less than 3 min	The answering system recording time is less than three minutes.
Line in use	An extension phone, or one of the handsets is in use.
Low battery	The battery needs to be recharged.
Microphone ON	The mute function is turned off and the other party can hear you.
Missed Reminder	There are reminders that have not been reviewed.
Muted	The mute function is turned on. The other party cannot hear you but you can hear the other party.
Memory full	The answering system has no remaining recording time.
New voicemail	There are new voicemail message(s) from the telephone service provider.
No answer. Try again.	When you send out an intercom request, the destination device is in use, out of range, not powered, or does not answer within 100 seconds. When you send out a transfer request, the destination device is in use, out of range or not powered.
No battery	The handset in the handset charger has no battery installed.
No line	There is no telephone line connected.

No response to transfer	When you send out a transfer request, the destination device does not answer within 30 seconds.
Not available at this time	Someone else is already accessing the phonebook, caller ID log or answering system.
Not enough batt to power base	The cordless handset you put in the base does not have enough charge to back up the telephone base power.
Number already saved	The telephone number you try to save is already in the phonebook.
Out of range OR Base no power	The telephone base has lost power, or the handset is out of range.
Phone	The handset is on a call.
Phonebook empty	There are no phonebook entries.
Phonebook full	The phonebook is full. You cannot save any new entries unless you delete some current entries.
PRIVATE NAME	The caller is blocking the name information.
PRIVATE NUMBER	The caller is blocking the telephone number information.
PRIVATE CALLER	The caller is blocking the name and the telephone number information.
Place in charger	The battery is very low. The handset should be charged.

Powering base...Don't Pick UP	A charged handset is put in the telephone base to back up the telephone base power for some basic phone operations during a power failure.
Put HS on base to Power base	The telephone base has lost power. Put the handset in the telephone base to back up the power.
Quiet mode is off	The quiet mode is turned off.
Quiet mode on	The quiet mode is turned on.
Rec mem full	The system recording time is full.
Rec mem low	The system recording time is low.
Recording...	The answering system is recording a message.
Registered	The handset is registered to the telephone base.
Registration failed	The registration is not successful.
Registering ** Please wait	The handset or pendant registration is in progress.
Reminder is turned ON	The reminder is automatically set to on.
Ringer muted	The ringer is muted temporarily while the handset is ringing.
Ringer off	The ringer is off temporarily during an incoming call.
Saved	Your selection has been saved.

Speaker	The handset speakerphone is in use.
To register HS, see manual	Screen display on a non-registered handset.
To screen call, Press [SELECT]	The system is recording a message. Press <b>SELECT</b> to screen a call on a handset.
Transferred	You have transferred an outside call to another cordless handset.
You don't have any reminders	There is no reminder in the telephone system.
UNKNOWN NAME	This caller's name is unavailable.
UNKNOWN NUMBER	This caller's number is unavailable.
UNKNOWN CALLER	No caller information is available about this caller.
XX Missed calls	There are new calls in the caller ID log.
XX New messages	There are new messages.
XX New reminders	There are new reminders.
** Paging **	The handset is being paged by the telephone base.

## **ECO mode**

This power conserving technology reduces power consumption for optimal battery performance. The ECO mode activates automatically whenever the handset is synchronized with the telephone base.

## **General product care**

### **Taking care of your telephone**

Your cordless telephone contains sophisticated electronic parts, so it must be treated with care.

### **Avoid rough treatment**

Place the handset down gently. Save the original packing materials to protect your telephone if you ever need to ship it.

### **Avoid water**

Your telephone can be damaged if it gets wet. Do not use the handset outdoors in the rain, or handle it with wet hands. Do not install the telephone base near a sink, bathtub or shower.

### **Electrical storms**

Electrical storms can sometimes cause power surges harmful to electronic equipment. For your own safety, take caution when using electrical appliances during storms.

### **Cleaning your telephone**

Your telephone has a durable plastic casing that should retain its luster for many years. Clean it only with a dry non-abrasive cloth. Do not use dampened cloth or cleaning solvents of any kind.

## Frequently asked questions

Below are the questions most frequently asked about the cordless telephone. If you cannot find the answer to your question, visit our website at [www.vtechphones.com](http://www.vtechphones.com) or call 1 (800) 595-9511 for customer service.

My telephone does not work at all.	Make sure the telephone base is installed properly, and battery is installed and charged correctly. For optimum daily performance, return the handset to the telephone base after use, and return the pendant to the pendant charger after use.
The display shows <b>No line</b> . I cannot hear the dial tone.	Disconnect the telephone line cord from your telephone and connect it to another telephone. If there is no dial tone on that other telephone either, then the telephone line cord may be defective. Try installing a new telephone line cord. If changing the telephone line cord does not help, the wall jack (or the wiring to this wall jack) may be defective. Contact your telephone service provider.
	You may be using a new cable or VoIP service, the existing telephone jacks in your home may no longer work. Contact your service provider for solutions.

I cannot dial out.	Make sure there is a dial tone before dialing. It is normal if the handset takes a second or two to synchronize with the telephone base before producing a dial tone. Wait an extra second before dialing.
	Eliminate any background noise. Mute the handset before dialing, or dial from another room in your home with less background noise.
The battery does not charge in the handset or the handset battery does not accept charge.	Make sure the handset is placed in the telephone base or charger correctly.
	If the battery is completely depleted, charge the battery for at least 30 minutes before use.
	You may need to purchase a new battery.
The pendant battery does not accept charge while in the pendant charger.	Clean the charging contacts on the pendant and pendant charger each month with a pencil eraser or cloth.
	Charge the battery in the pendant for at least 3 hours. For optimum daily performance, return the pendant to the pendant charger when not in use.
	If the battery is completely depleted, charge the pendant for at least 30 minutes before use.
The telephone does not ring when there is an incoming call.	Make sure the ringer volume is not set to off.
	The handset may be too far from the telephone base. Move it closer to the telephone base.
I experience poor sound quality when using the handset speakerphone.	For increased sound quality while using the handset speakerphone, place the handset on a flat surface with the dialing keys facing up.

I hear other calls when using the telephone.	Disconnect the telephone base from the telephone wall jack. Plug in a different telephone. If you still hear other calls, the problem is probably in the wiring or telephone service. Contact your telephone service provider.
There is interference during a telephone conversation. My calls fade out when I am using the cordless handset.	The handset may be out of range. Move it closer to the telephone base.
	If you subscribe to high-speed Internet service (DSL - digital subscriber line) through your telephone line, you must install a DSL filter between the telephone line cord and the telephone wall jack. The filter prevents noise and caller ID problems caused by DSL interference. Contact your DSL service provider for more information about DSL filters.
	Appliances or other cordless telephones plugged into the same circuit as the telephone base can cause interference. Try moving the appliance or telephone base to another outlet.
	The location of your telephone base can impact the performance of your cordless phone. For better reception, install the telephone base in a centralized location within your home or office, away from walls or other obstructions. In many environments, elevating the telephone base improves overall performance.

The telephone does not receive caller ID or the telephone does not show caller ID during call waiting.	Caller ID is a subscription service. You must subscribe to this service from your telephone service provider for this feature to work on your telephone.
	Both your and the caller's telephone service providers must use equipment compatible with the caller ID service.
	The caller may not be calling from an area which supports caller ID.
The display shows <b>Out of range</b> OR <b>Base no power</b> .	The caller ID information displays after the first or second ring.
	The handset may be out of range. Move it closer to the telephone base. Make sure the power cord is securely plugged into the telephone base. Use a working electrical outlet not controlled by a wall switch.
The outgoing announcement is not clear.	When recording the announcement, make sure you speak in a normal tone of voice towards the microphone of the handset.
	Make sure there is no background noise when recording.

The answering system does not answer after the correct number of rings.	Make sure that the answering system is on.
	If toll saver is activated, the number of rings changes to two when you have new messages stored.
	If the memory is full or the system is off, the system will answer after 10 rings.
	If you subscribe to voicemail service, change the number of rings so that your answering system answers before your voicemail answers. To determine how many rings activate your voicemail, contact your telephone service provider.
The answering system does not record messages.	Make sure the answering system is on. When the answering system is on, <b>ANS ON</b> should display on the handset and the telephone base.
	When the answering machine memory is full, it does not record new messages until some old messages are deleted.
	If you subscribe to voicemail service, change the number of rings so that your answering system answers before your voicemail service answers. To determine how many rings activate your voicemail service, contact your telephone service provider.
The answering system does not announce the correct day of the week for recorded messages time stamp.	Make sure you have set the date and time. See <b>Configure your telephone</b> section.

The messages on the answering system are incomplete.	If a caller leaves a very long message, part of it may be lost when the answering system disconnects the call after the preset recording time.
	If the memory on the answering system becomes full during a message, the answering system stops recording and disconnects the call.
	If the caller's voice is very soft, the answering system may stop recording and disconnect the call.
The answering system does not respond to remote commands.	Make sure you enter the correct remote access code.
	Make sure you are calling from a touch-tone telephone. When dialing a number, there should be tones. If there are clicks, then it is not a touch-tone telephone and cannot activate the answering system.
	The answering system may not detect the remote access code when your announcement is playing. Wait until the announcement is over before entering the code.
I accidentally set my LCD language to Spanish or French, and I don't know how to change it back to English.	While the handset is not in use, press <b>MENU</b> and then enter <b>*364#</b> to change the handset LCD language back to English.



## The RBRC® seal

The RBRC® seal on the nickel-metal hydride battery indicates that VTech Communications, Inc. is voluntarily participating in an industry program to collect and recycle these batteries at the end of their useful lives, when taken out of service within the United States and Canada.

The RBRC® program provides a convenient alternative to placing used nickel-metal hydride batteries into the trash or municipal waste, which may be illegal in your area.

VTech's participation in RBRC® makes it easy for you to drop off the spent battery at local retailers participating in the RBRC® program or at authorized VTech product service centers. Please call **1 (800) 8 BATTERY™** for information on Ni-MH battery recycling and disposal bans/restrictions in your area. VTech's involvement in this program is part of its commitment to protecting our environment and conserving natural resources.

**RBRC® is a registered trademark of Rechargeable Battery Recycling Corporation.**



The RBRC® seal on the lithium-ion battery indicates that VTech Communications, Inc. is voluntarily participating in an industry program to collect and recycle these batteries at the end of their useful lives, when taken out of service within the United States and Canada.

The RBRC® program provides a convenient alternative to placing used lithium-ion batteries into the trash or municipal waste, which may be illegal in your area.

VTech's participation in RBRC® makes it easy for you to drop off the spent battery at local retailers participating in the RBRC® program or at authorized VTech product service centers. Please call **1 (800) 8 BATTERY™** for information on Li-ion battery recycling and disposal bans/restrictions in your area. VTech's involvement in this program is part of its commitment to protecting our environment and conserving natural resources.

**RBRC® is a registered trademark of Rechargeable Battery Recycling Corporation.**



# FCC, ACTA and IC regulations

## FCC Part 15

This equipment has been tested and found to comply with the requirements for a Class B digital device under Part 15 of the Federal Communications Commission (FCC) rules. These requirements are intended to provide reasonable protection against harmful interference in a residential installation. This equipment generates, uses and can radiate radio frequency energy and, if not installed and used in accordance with the instructions, may cause harmful interference to radio communications. However, there is no guarantee that interference will not occur in a particular installation. If this equipment does cause harmful interference to radio or television reception, which can be determined by turning the equipment off and on, the user is encouraged to try to correct the interference by one or more of the following measures:

- Reorient or relocate the receiving antenna.
- Increase the separation between the equipment and receiver.
- Connect the equipment into an outlet on a circuit different from that to which the receiver is connected.
- Consult the dealer or an experienced radio/TV technician for help.

Changes or modifications to this equipment not expressly approved by the party responsible for compliance could void the user's authority to operate the equipment.

This device complies with Part 15 of the FCC rules. Operation is subject to the following two conditions: (1) this device

may not cause harmful interference, and (2) this device must accept any interference received, including interference that may cause undesired operation. Privacy of communications may not be ensured when using this telephone.

To ensure safety of users, the FCC has established criteria for the amount of radio frequency energy that can be safely absorbed by a user or bystander according to the intended usage of the product. This product has been tested and found to comply with the FCC criteria. The handset may be safely held against the ear of the user. The telephone base shall be installed and used such that parts of the user's body other than the hands are maintained at a distance of approximately 20 cm (8 inches) or more.

This Class B digital apparatus complies with Canadian requirement: CAN ICES-3 (B)/NMB-3(B).

## FCC Part 68 and ACTA

This equipment complies with Part 68 of the FCC rules and with technical requirements adopted by the Administrative Council for Terminal Attachments (ACTA). The label on the back or bottom of this equipment contains, among other things, a product identifier in the format US:AAAEQ##TXXXX. This identifier must be provided to your telephone service provider upon request.

The plug and jack used to connect this equipment to premises wiring and the telephone network must comply with applicable Part 68 rules and technical requirements adopted by ACTA. A compliant telephone cord and modular plug is provided with this product.

It is designed to be connected to a compatible modular jack that is also compliant. An RJ11 jack should normally be used for connecting to a single line and an RJ14 jack for two lines. See the installation instructions in the user's manual.

The Ringer Equivalence Number (REN) is used to determine how many devices you may connect to your telephone line and still have them ring when you are called. The REN for this product is encoded as the 6th and 7th characters following the US: in the product identifier (e.g., if ## is 03, the REN is 0.3). In most, but not all areas, the sum of all RENs should be five (5.0) or less. For more information, please contact your telephone service provider.

This equipment may not be used with Party Lines. If you have specially wired alarm dialing equipment connected to your telephone line, ensure the connection of this equipment does not disable your alarm equipment. If you have questions about what will disable alarm equipment, consult your telephone service provider or a qualified installer.

If this equipment is malfunctioning, it must be unplugged from the modular jack until the problem has been corrected. Repairs to this telephone equipment can only be made by the manufacturer or its authorized agents. For repair procedures, follow the instructions outlined under the Limited warranty.

If this equipment is causing harm to the telephone network, the telephone service provider may temporarily discontinue your telephone service. The telephone service provider is required to notify you before interrupting service. If advance notice is not practical, you will be notified

as soon as possible. You will be given the opportunity to correct the problem and the telephone service provider is required to inform you of your right to file a complaint with the FCC. Your telephone service provider may make changes in its facilities, equipment, operation, or procedures that could affect the proper functioning of this product. The telephone service provider is required to notify you if such changes are planned.

If this product is equipped with a corded or cordless handset, it is hearing aid compatible.

If this product has memory dialing locations, you may choose to store emergency telephone numbers (e.g., police, fire, medical) in these locations. If you do store or test emergency numbers, please:

Remain on the line and briefly explain the reason for the call before hanging up. Perform such activities in off-peak hours, such as early morning or late evening.

## **Industry Canada**

This device complies with Industry Canada licence-exempt RSS standard(s).

Operation is subject to the following two conditions: (1) this device may not cause harmful interference, and (2) this device must accept any interference, including interference that may cause undesired operation.

Privacy of communications may not be ensured when using this telephone.

The term "IC:" before the certification/registration number only signifies that the Industry Canada technical specifications were met.

The Ringer Equivalence Number (REN)

for this terminal equipment is 1.0. The REN is an indication of the maximum number of devices allowed to be connected to a telephone interface. The termination on an interface may consist of any combination of devices subject only to the requirement that the sum of the RENs of all the devices does not exceed five.

This product meets the applicable Industry Canada technical specifications.

## California Energy Commission battery charging testing instructions

This telephone is set up to comply with the energy-conserving standards right out of the box. These instructions are intended for California Energy Commission (CEC) compliance testing only. When the CEC battery charging testing mode is activated, all telephone functions, except battery charging, will be disabled.

### To activate the CEC battery charging testing mode:

1. Unplug the telephone base power adapter from the power outlet. Make sure all handsets are plugged with charged batteries before proceeding.
2. While you press and hold **⏏/FIND HANDSET**, plug the telephone base power adapter back to the power outlet.
3. After about 20 seconds, when the **IN USE** light starts flashing, release **⏏/FIND HANDSET** and then press it again within 2 seconds.

### NOTES

- When the phone successfully enters the CEC battery charging testing mode, the **IN USE** light turns off and all handsets display **To register HS, see manual**.
- When the phone fails to enter this mode, repeat Step 1 through Step 3 above.

### To deactivate the CEC battery charging testing mode:

1. Unplug the telephone base power adapter from the power outlet, then plug it back in. Then the telephone base is powered up as normal.
2. Register your handsets and pendants back to the telephone base. Refer to **Add and register a handset** and **Add and register a pendant**.

## For C-UL compliance only

### Mesures de sécurité importantes

Afin de réduire les risques d'incendie, de blessures corporelles ou d'électrocution, suivez toujours ces mesures préventives de base lorsque vous utilisez votre téléphone :

1. Lisez et comprenez bien toutes les instructions.
2. Observez toutes les instructions et mises en garde inscrites sur l'appareil.
3. Débranchez ce téléphone de la prise murale avant de le nettoyer. N'utilisez pas de nettoyeurs liquides ni en aérosol. N'utilisez qu'un chiffon doux et légèrement humecté.
4. N'utilisez pas ce produit près de l'eau, tel que près d'un bain, d'un lavabo, d'un évier de cuisine, d'un bac de lavage ou d'une piscine, ou dans un sous-sol humide ou sous la douche.
5. Ne déposez pas ce téléphone sur un chariot, support ou table chancelants. L'appareil pourrait tomber et être sérieusement endommagé.
6. Le boîtier de l'appareil est doté de fentes et d'ouvertures d'aération situées à l'arrière ou en dessous. Afin d'empêcher la surchauffe, ces ouvertures ne doivent pas être obstruées en plaçant l'appareil sur un lit, divan, tapis ou autre surface similaires. Ne placez pas cet appareil à proximité d'un élément de chauffage ni d'une plinthe électrique. De plus, ne l'installez pas dans une unité murale ou un cabinet fermé qui ne possède pas d'aération adéquate.
7. Ne faites fonctionner cet appareil qu'avec le type d'alimentation indiqué sur les étiquettes de l'appareil. Si vous ne connaissez pas le voltage de votre maison, consultez votre marchand ou votre fournisseur d'électricité.
8. Ne déposez rien sur le cordon d'alimentation. Installez cet appareil dans un endroit sécuritaire, là où personne ne pourra trébucher sur la ligne d'alimentation ni le cordon téléphonique modulaire.
9. N'insérez jamais d'objets à travers les fentes et ouvertures de cet appareil, car ils pourraient toucher à des points de tension dangereux ou court-circuiter des pièces, ce qui constituerait un risque d'incendie ou d'électrocution. N'échappez pas de liquides dans l'appareil.
10. Afin de réduire les risques d'électrocution, ne démontez pas l'appareil, mais apportez-le plutôt à un centre de service qualifié s'il doit être réparé. En enlevant le couvercle, vous vous exposez à des tensions dangereuses ou autres dangers similaires. Un remontage inadéquat peut être à l'origine d'une électrocution lors d'une utilisation ultérieure de l'appareil. Débranchez l'appareil avant de procéder au nettoyage. Utilisez un chiffon humide et doux.
11. Ne surchargez pas les prises de courant et les rallonges.
12. Débranchez cet appareil de la prise de courant et communiquez avec le département de service à la clientèle de VTech dans les cas suivants :
  - Lorsque le cordon d'alimentation est endommagé ou écorché.
  - Si du liquide a été échappé dans l'appareil.
  - Si l'appareil a été exposé à une source d'humidité telle que la pluie ou l'eau.



- Si le produit ne fonctionne pas normalement en respectant les instructions de fonctionnement. Réglez uniquement les commandes indiquées dans les instructions de fonctionnement. Les réglages incorrects des autres commandes pourraient provoquer un dommage qui pourrait exiger un travail exhaustif de la part d'un technicien autorisé afin de rétablir le fonctionnement normal de l'appareil.
  - Si le produit a été échappé et que le socle et/ou le combiné a été endommagé.
  - Si le produit affiche une nette diminution de sa performance.
13. Évitez d'utiliser un téléphone (autre qu'un sans fil) pendant un orage. Les éclairs peuvent être à l'origine d'une électrocution.
14. N'utilisez pas le téléphone pour rapporter une fuite de gaz à proximité de la fuite. En certaines circonstances, une flammèche pourrait être provoquée lorsque l'adaptateur est branché à une prise de courant, ou lorsque le combiné est déposé sur le socle. Ceci est un événement commun associé à la fermeture d'un circuit électrique. L'utilisateur ne devrait pas brancher le téléphone à une prise de courant, et ne devrait pas déposer le combiné chargé sur le socle, si le téléphone se trouve à proximité d'un endroit comportant des concentrations de gaz inflammables, à moins que la ventilation soit adéquate. Une flammèche dans un tel endroit pourrait provoquer un incendie ou une explosion. De tels environnements peuvent comprendre: des endroits où l'on utilise de l'oxygène médical sans ventilation adéquate; des gaz

industriels (dissolvants de nettoyage, des vapeurs d'essence, etc.); une fuite de gaz naturel, etc.

15. Ne placez que le combiné de votre téléphone près de votre oreille lorsqu'en mode de conversation.
16. Ces adaptateurs ont été conçus pour être orientés en position verticale ou montés au sol. Les broches ne sont pas conçues pour maintenir l'adaptateur en place si celui-ci est branché dans une prise au plafond ou sous une table/ armoire.

## CONSERVEZ CES INSTRUCTIONS

### Pile

- MISE EN GARDE : N'utilisez que la pile incluse.
- Ne jetez pas la pile au feu. Vérifiez les instructions spécifiques de mise aux rebus auprès des autorités locales.
- N'ouvrez pas et ne mutilez pas la pile. L'électrolyte qui s'en échapperait est corrosif et pourrait causer des brûlures ou des blessures aux yeux ou à la peau. L'électrolyte est toxique si avalé.
- Soyez prudents lorsque vous manipulez les piles afin d'éviter les courts-circuits provoqués par des matériaux conducteurs.
- Rechargez la pile incluse avec cet appareil, selon les instructions et limites spécifiées dans ce guide d'utilisation.

### Stimulateurs cardiaques implantés dans l'organisme

Les simulateurs cardiaques (s'applique uniquement aux téléphones numériques sans fil) :

L'organisme 'Wireless Technology Research, LLC (WTR)', une firme de recherche indépendante, a mené une évaluation pluridisciplinaire des



interférences entre les téléphones sans fil portatifs et les stimulateurs cardiaques implantés dans l'organisme. Appuyée par l'Administration des aliments et drogues (FDA) des États-Unis, la firme WTR recommande aux médecins :

### **Avis aux détenteurs de stimulateurs cardiaques**

- Ils doivent tenir le téléphone sans fil à une distance d'au moins six pouces du stimulateur cardiaque.
- Ils ne doivent PAS placer le téléphone sans fil directement sur le stimulateur cardiaque, tel que dans une poche de chemise, lorsque celui-ci est en marche.
- Ils doivent utiliser le téléphone sans fil en l'appuyant sur l'oreille qui se trouve dans la direction opposée au stimulateur cardiaque.

L'étude effectuée par l'organisme WRS n'a pas identifié de risque pour les détenteurs de simulateurs cardiaques causés par les gens qui utilisent un téléphone sans fil à proximité de ceux-ci.

**Remarque :** Le transmetteur CareLine<sup>MC</sup> est un téléphone sans fil : il ne doit pas être utilisé comme pendentif (accroché à une chaîne sur la région du coeur) par des personnes portant un stimulateur cardiaque. Les patients qui ont un stimulateur cardiaque doivent uniquement porter leur produit CareLine<sup>MC</sup> à la ceinture.

### **À propos des téléphones sans fil**

- **Confidentialité :** Les mêmes caractéristiques qui constituent des avantages pour les téléphones sans fil affichent également des restrictions. Les appels téléphoniques sont transmis entre le combiné sans fil et le socle par le biais d'ondes radio ; il y a donc la possibilité que vos conversations téléphoniques

sans fil soient interceptées par des équipements de réception radio se trouvant dans la portée du combiné sans fil. Pour cette raison, vous ne devez pas percevoir les communications téléphoniques sans fil comme étant aussi confidentielles que celles des téléphones à cordons.

- **Alimentation électrique :** Le socle de ce téléphone sans fil doit être branché à une prise électrique fonctionnelle. La prise électrique ne doit pas être contrôlée par un interrupteur mural. Les appels ne pourront pas être effectués du combiné sans fil si le socle est débranché ou mis hors tension ou si le courant est coupé.
- **Possibilité d'interférences aux téléviseurs :** Certains téléphones sans fil fonctionnent sur des fréquences pouvant causer des interférences aux téléviseurs et aux magnétoscopes. Pour réduire ou prévenir de telles interférences, ne placez pas le socle du téléphone sans fil près ou sur un téléviseur ou magnétoscope. S'il y a présence de parasites, il est conseillé d'éloigner le téléphone sans fil du téléviseur ou du magnétoscope afin de réduire possiblement les interférences.
- **Piles rechargeables :** Manipulez les piles avec soin afin de ne pas les court-circuiter avec des bagues, bracelets ou clés. Les piles ou le conducteur peut surchauffer et causer des blessures. Respectez la polarité adéquate entre la pile et le chargeur.
- **Les bloc-piles rechargeables à l'hydrure métallique de nickel :** Jetez ces blocs-piles de manière écologique et sécuritaire. Ne les incinerez pas et ne les percez pas. Tel que les autres piles de ce type, elles pourraient dégager une matière toxique qui peut causer des blessures corporelles si elles sont brûlées ou percées.

## Limited warranty

### What does this limited warranty cover?

The manufacturer of this VTech Product warrants to the holder of a valid proof of purchase (“Consumer” or “you”) that the Product and all accessories provided in the sales package (“Product”) are free from defects in material and workmanship, pursuant to the following terms and conditions, when installed and used normally and in accordance with the Product operating instructions. This limited warranty extends only to the Consumer for Products purchased and used in the United States of America and Canada.

### What will VTech do if the Product is not free from defects in materials and workmanship during the limited warranty period (“Materially Defective Product”)?

During the limited warranty period, VTech’s authorized service representative will repair or replace at VTech’s option, without charge, a Materially Defective Product. If we repair the Product, we may use new or refurbished replacement parts. If we choose to replace the Product, we may replace it with a new or refurbished Product of the same or similar design. We will retain defective parts, modules, or equipment. Repair or replacement of the Product, at VTech’s option, is your exclusive remedy. VTech will return the repaired or replacement Products to you in working condition. You should expect the repair or replacement to take approximately 30 days.

### How long is the limited warranty period?

The limited warranty period for the

Product extends for ONE (1) YEAR from the date of purchase. If VTech repairs or replaces a Materially Defective Product under the terms of this limited warranty, this limited warranty also applies to the repaired or replacement Product for a period of either (a) 90 days from the date the repaired or replacement Product is shipped to you or (b) the time remaining on the original one-year warranty; whichever is longer.

### What is not covered by this limited warranty?

This limited warranty does not cover:

1. Product that has been subjected to misuse, accident, shipping or other physical damage, improper installation, abnormal operation or handling, neglect, inundation, fire, water or other liquid intrusion;
2. Product that has been damaged due to repair, alteration or modification by anyone other than an authorized service representative of VTech;
3. Product to the extent that the problem experienced is caused by signal conditions, network reliability, or cable or antenna systems;
4. Product to the extent that the problem is caused by use with non-VTech accessories;
5. Product whose warranty/quality stickers, product serial number plates or electronic serial numbers have been removed, altered or rendered illegible;
6. Product purchased, used, serviced, or shipped for repair from outside the United States of America or Canada, or used for commercial or institutional purposes (including but not limited to Products used for rental purposes);
7. Product returned without a valid proof

- of purchase (see item 2 below); or
- Charges for installation or set up, adjustment of customer controls, and installation or repair of systems outside the unit.

### **How do you get warranty service?**

To obtain warranty service in the USA, please visit our website at [www.vtechphones.com](http://www.vtechphones.com) or call 1 (800) 595-9511. In Canada, go to [www.vtechcanada.com](http://www.vtechcanada.com) or call 1 (800) 267-7377.

**NOTE:** Before calling for service, please review the user's manual - a check of the Product's controls and features may save you a service call.

Except as provided by applicable law, you assume the risk of loss or damage during transit and transportation and are responsible for delivery or handling charges incurred in the transport of the Product(s) to the service location. VTech will return repaired or replaced Product under this limited warranty. Transportation, delivery or handling charges are prepaid. VTech assumes no risk for damage or loss of the Product in transit. If the Product failure is not covered by this limited warranty, or proof of purchase does not meet the terms of this limited warranty, VTech will notify you and will request that you authorize the cost of repair prior to any further repair activity. You must pay for the cost of repair and return shipping costs for the repair of Products that are not covered by this limited warranty.

### **What must you return with the Product to get warranty service?**

- Return the entire original package and contents including the Product to the VTech service location along with a description of the malfunction or difficulty; and

- Include a "valid proof of purchase" (sales receipt) identifying the Product purchased (Product model) and the date of purchase or receipt; and
- Provide your name, complete and correct mailing address, and telephone number.

### **Other limitations**

This warranty is the complete and exclusive agreement between you and VTech. It supersedes all other written or oral communications related to this Product. VTech provides no other warranties for this Product. The warranty exclusively describes all of VTech's responsibilities regarding the Product. There are no other express warranties. No one is authorized to make modifications to this limited warranty and you should not rely on any such modification.

**State/Provincial Law Rights:** This warranty gives you specific legal rights, and you may also have other rights, which vary from state to state or province to province.

**Limitations:** Implied warranties, including those of fitness for a particular purpose and merchantability (an unwritten warranty that the Product is fit for ordinary use) are limited to one year from the date of purchase. Some states/provinces do not allow limitations on how long an implied warranty lasts, so the above limitation may not apply to you. In no event shall VTech be liable for any indirect, special, incidental, consequential, or similar damages (including, but not limited to lost profits or revenue, inability to use the Product or other associated equipment, the cost of substitute equipment, and claims by third parties) resulting from the use of this Product. Some states/provinces do

not allow the exclusion or limitation of incidental or consequential damages, so the above limitation or exclusion may not apply to you.

**Please retain your original sales receipt as proof of purchase.**

## Technical specifications

---

Frequency control	Crystal controlled PLL synthesizer
-------------------	------------------------------------

---

Transmit frequency	1921.536-1928.448 MHz
--------------------	-----------------------

---

Channels	5
----------	---

---

Nominal effective range	Maximum power allowed by FCC and IC. Actual operating range may vary according to environmental conditions at the time of use.
-------------------------	--

---

Power requirements	Telephone base: 6V DC @ 400mA Handset charger: 6V AC @ 300mA Handset battery: 2.4V Ni-MH Pendant charger: 6V DC @ 400mA Pendant battery: 3.7V Li-ion
--------------------	---

---

Memory	Phonebook: 50 memory locations; up to 30 digits and 15 characters Caller ID log: 50 memory locations; up to 24 digits and 15 characters
--------	--

---



Designed to fit your home.  
And your life.

VTech Communications, Inc.  
A member of THE VTECH GROUP OF COMPANIES.  
VTech is a registered trademark of VTech Holdings Limited.  
Specifications are subject to change without notice.  
© 2014 VTech Communications, Inc.  
All rights reserved. 06/14. SN6187\_WEB CIB\_V2.0  
Document order number: 91-006706-020-100

